

SEMITRANS® 3

Trench IGBT Module

SKM 400GB126D

SKM 400GAL126D

Preliminary Data

Features

- Homogeneous Si
- Trench = Trenchgate technology
- V_{CEsat} with positive temperature coefficient
- High short circuit capability, self limiting to $6 \times I_C$

Typical Applications

- AC inverter drives
- UPS
- Electronic welders

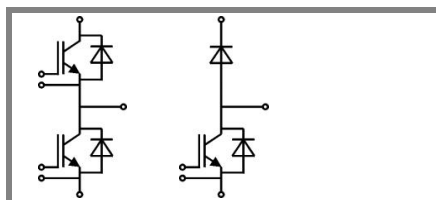

GB

GAL

Absolute Maximum Ratings		$T_C = 25^\circ\text{C}$, unless otherwise specified		
Symbol	Conditions	Values		Units
IGBT				
V_{CES}	$T_j = 25^\circ\text{C}$	1200		V
I_C	$T_j = 150^\circ\text{C}$	$T_{case} = 25^\circ\text{C}$	470	A
		$T_{case} = 80^\circ\text{C}$	330	A
I_{CRM}	$I_{CRM} = 2 \times I_{Cnom}$	600		A
V_{GES}		± 20		V
t_{psc}	$V_{CC} = 600\text{ V}; V_{GE} \leq 20\text{ V}; T_j = 125^\circ\text{C}$ $V_{CES} < 1200\text{ V}$	10		μs
Inverse Diode				
I_F	$T_j = 150^\circ\text{C}$	$T_{case} = 25^\circ\text{C}$	400	A
		$T_{case} = 80^\circ\text{C}$	270	A
I_{FRM}	$I_{FRM} = 2 \times I_{Fnom}$	600		A
I_{FSM}	$t_p = 10\text{ ms}; \text{sin.}$	$T_j = 150^\circ\text{C}$	2200	A
Freewheeling Diode				
I_F	$T_j = 150^\circ\text{C}$	$T_{case} = 25^\circ\text{C}$	400	A
		$T_{case} = 80^\circ\text{C}$	270	A
I_{FRM}	$I_{FRM} = 2 \times I_{Fnom}$	600		A
I_{FSM}	$t_p = 10\text{ ms}; \text{sin.}$	$T_j = 150^\circ\text{C}$	2200	A
Module				
$I_{t(RMS)}$		500		A
T_{vj}		- 40 ... + 150		$^\circ\text{C}$
T_{stg}		- 40 ... + 125		$^\circ\text{C}$
V_{isol}	AC, 1 min.	4000		V

Characteristics		$T_C = 25^\circ\text{C}$, unless otherwise specified			
Symbol	Conditions	min.	typ.	max.	Units
IGBT					
$V_{GE(th)}$	$V_{GE} = V_{CE}, I_C = 12\text{ mA}$	5	5,8	6,5	V
I_{CES}	$V_{GE} = 0\text{ V}, V_{CE} = V_{CES}$		0,15	0,45	mA
V_{CE0}		$T_j = 25^\circ\text{C}$	1	1,2	V
		$T_j = 125^\circ\text{C}$	0,9		V
r_{CE}	$V_{GE} = 15\text{ V}$	$T_j = 25^\circ\text{C}$	2,3	3,2	$\text{m}\Omega$
		$T_j = 125^\circ\text{C}$	3,7		$\text{m}\Omega$
$V_{CE(sat)}$	$I_{Cnom} = 300\text{ A}, V_{GE} = 15\text{ V}$	$T_j = 25^\circ\text{C}_{chiplev.}$	1,7	2,15	V
		$T_j = 125^\circ\text{C}_{chiplev.}$	2		V
C_{ies}	$V_{CE} = 25, V_{GE} = 0\text{ V}$	$f = 1\text{ MHz}$	23,1		nF
C_{oes}			1,9		nF
C_{res}			1,2		nF
Q_G	$V_{GE} = -8\text{ V} \dots +20\text{ V}$	2800		nC	
R_{Gint}	$T_j = ^\circ\text{C}$	2,5		Ω	
$t_{d(on)}$	$R_{Gon} = 2\ \Omega$	$V_{CC} = 600\text{ V}$ $I_{Cnom} = 300\text{ A}$	330		ns
t_r			50		ns
E_{on}	$R_{Goff} = 2\ \Omega$	$T_j = 125^\circ\text{C}$ $V_{GE} = \pm 15\text{ V}$	29		mJ
$t_{d(off)}$			650		ns
t_f			110		ns
E_{ff}			48		mJ
$R_{th(j-c)}$	per IGBT			0,08	K/W

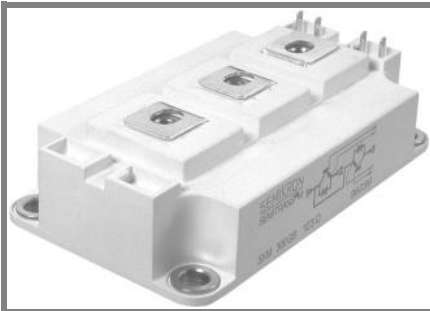

SEMITRANS® 3

Trench IGBT Module

SKM 400GB126D

SKM 400GAL126D

Preliminary Data

Features

- Homogeneous Si
- Trench = Trenchgate technology
- V_{CEsat} with positive temperature coefficient
- High short circuit capability, self limiting to $6 \times I_c$

Typical Applications

- AC inverter drives
- UPS
- Electronic welders

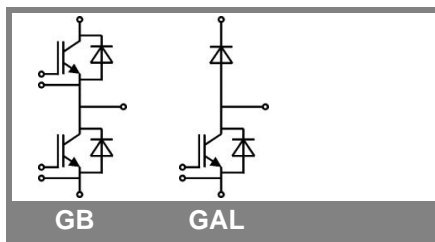

GB

GAL

Characteristics		min.	typ.	max.	Units
Inverse Diode					
$V_F = V_{EC}$	$I_{Fnom} = 300 \text{ A}; V_{GE} = 0 \text{ V}$		1,6	1,8	V
			1,6	1,8	V
V_{F0}			1	1,1	V
			0,8	0,9	V
r_F			2	2,3	mΩ
			2,7	3	mΩ
I_{RRM}	$I_{Fnom} = 300 \text{ A}$		390		A
Q_{rr}	$di/dt = 6300 \text{ A}/\mu\text{s}$		77		μC
E_{rr}	$V_{GE} = -15 \text{ V}; V_{CC} = 600 \text{ V}$		27		mJ
$R_{th(j-c)D}$	per diode			0,18	K/W
Freewheeling Diode					
$V_F = V_{EC}$	$I_{Fnom} = 300 \text{ A}; V_{GE} = 0 \text{ V}$		1,6	1,8	V
			1,6	1,8	V
V_{F0}			1	1,1	V
			0,8	0,9	V
r_F			2	2,3	V
			2,7	3	V
I_{RRM}	$I_{Fnom} = 300 \text{ A}$		390		A
Q_{rr}	$di/dt = 6300 \text{ A}/\mu\text{s}$		77		μC
E_{rr}	$V_{GE} = -15 \text{ V}; V_{CC} = 600 \text{ V}$		27		mJ
$R_{th(j-c)D}$	per diode			0,18	K/W
Module					
L_{CE}			15	20	nH
$R_{CC'+EE'}$	res., terminal-chip	$T_{case} = 25 \text{ °C}$	0,35		mΩ
		$T_{case} = 125 \text{ °C}$	0,5		mΩ
$R_{th(c-s)}$	per module			0,038	K/W
M_s	to heat sink M6		3	5	Nm
M_t	to terminals M6		2,5	5	Nm
w				325	g

This is an electrostatic discharge sensitive device (ESDS), international standard IEC 60747-1, Chapter IX.

This technical information specifies semiconductor devices but promises no characteristics. No warranty or guarantee expressed or implied is made regarding delivery, performance or suitability.

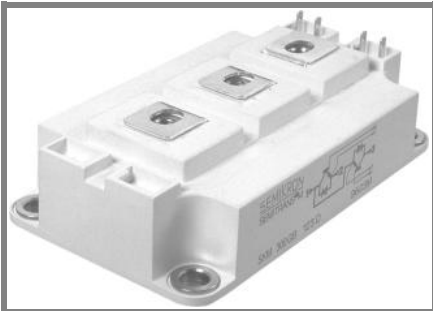

SEMITRANS® 3

Trench IGBT Module

SKM 400GB126D

SKM 400GAL126D

Preliminary Data

Features

- Homogeneous Si
- Trench = Trenchgate technology
- V_{CEsat} with positive temperature coefficient
- High short circuit capability, self limiting to $6 \times I_c$

Typical Applications

- AC inverter drives
- UPS
- Electronic welders

Z_{th}			
Symbol	Conditions	Values	Units
$Z_{th(j-c)I}$			
$R_{\theta j-c}$	$i = 1$	55	mk/W
$R_{\theta j-c}$	$i = 2$	21	mk/W
$R_{\theta j-c}$	$i = 3$	3,6	mk/W
$R_{\theta j-c}$	$i = 4$	0,4	mk/W
$\tau_{\theta j-c}$	$i = 1$	0,0393	s
$\tau_{\theta j-c}$	$i = 2$	0,0171	s
$\tau_{\theta j-c}$	$i = 3$	0,002	s
$\tau_{\theta j-c}$	$i = 4$	0,0002	s
$Z_{th(j-c)D}$			
$R_{\theta j-c}$	$i = 1$	120	mk/W
$R_{\theta j-c}$	$i = 2$	48	mk/W
$R_{\theta j-c}$	$i = 3$	10	mk/W
$R_{\theta j-c}$	$i = 4$	2	mk/W
$\tau_{\theta j-c}$	$i = 1$	0,0262	s
$\tau_{\theta j-c}$	$i = 2$	0,0417	s
$\tau_{\theta j-c}$	$i = 3$	0,0012	s
$\tau_{\theta j-c}$	$i = 4$	0,001	s

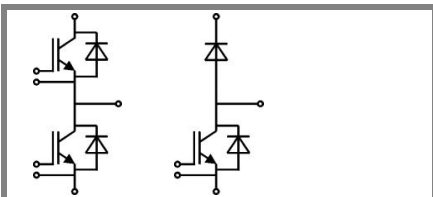

GB

GAL

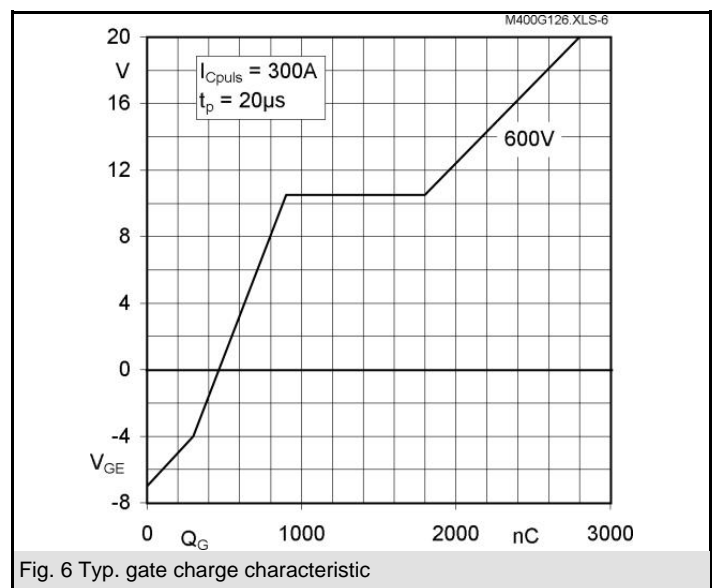
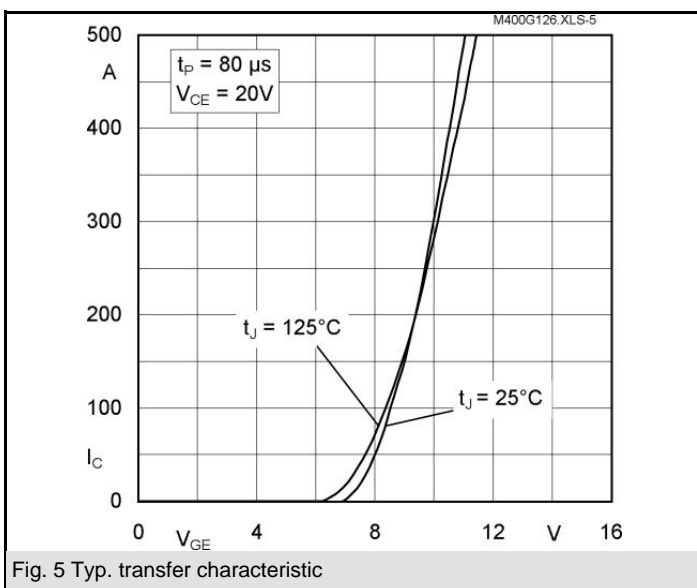
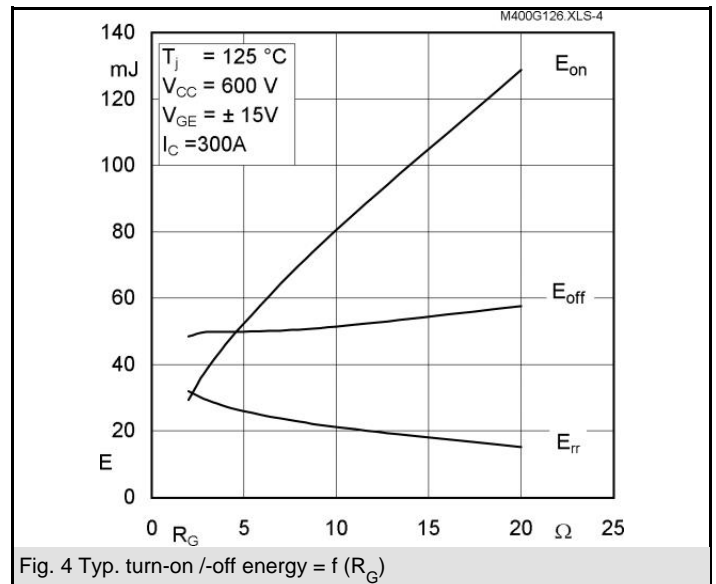
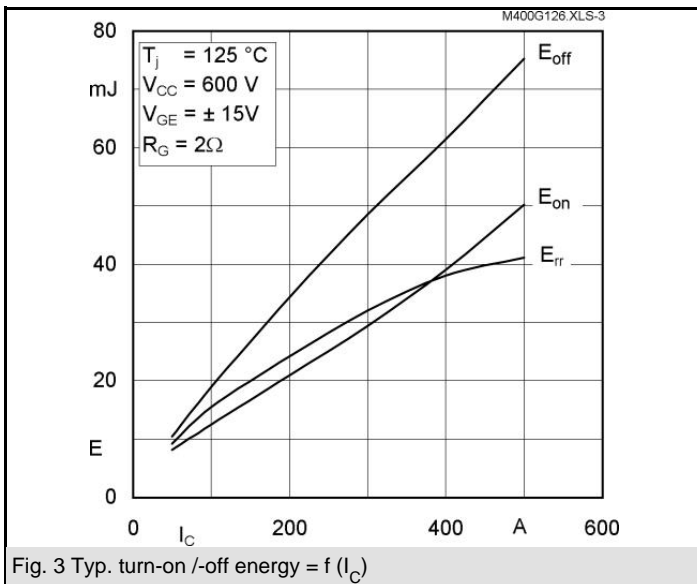
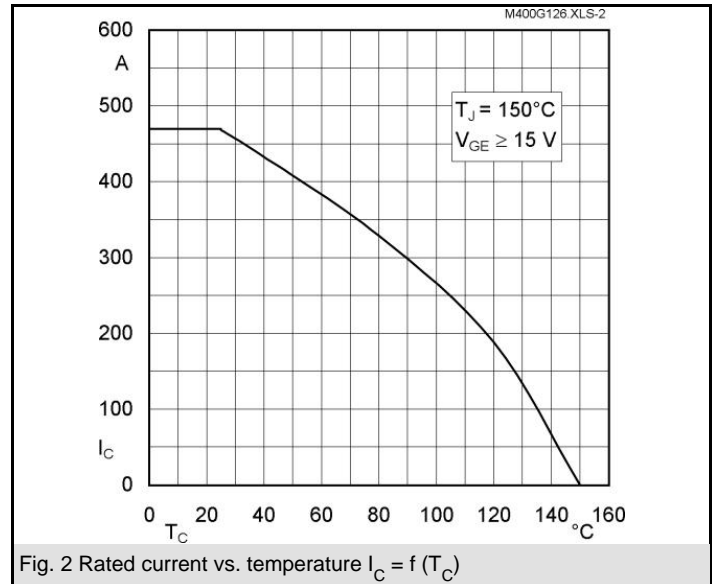
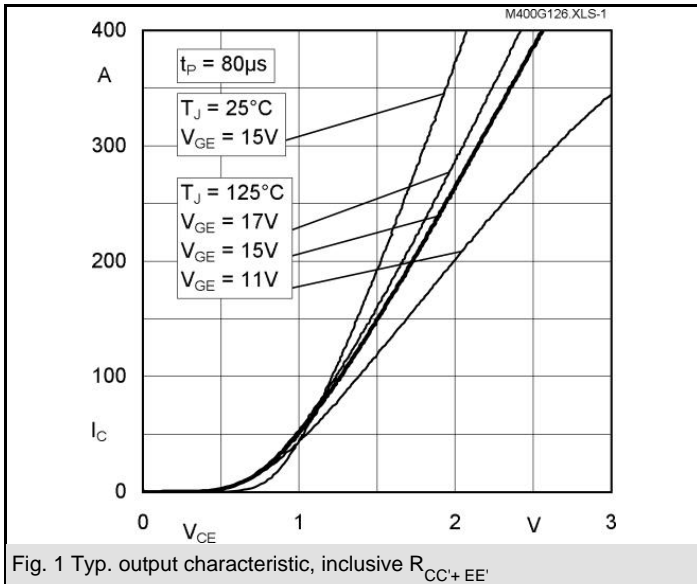

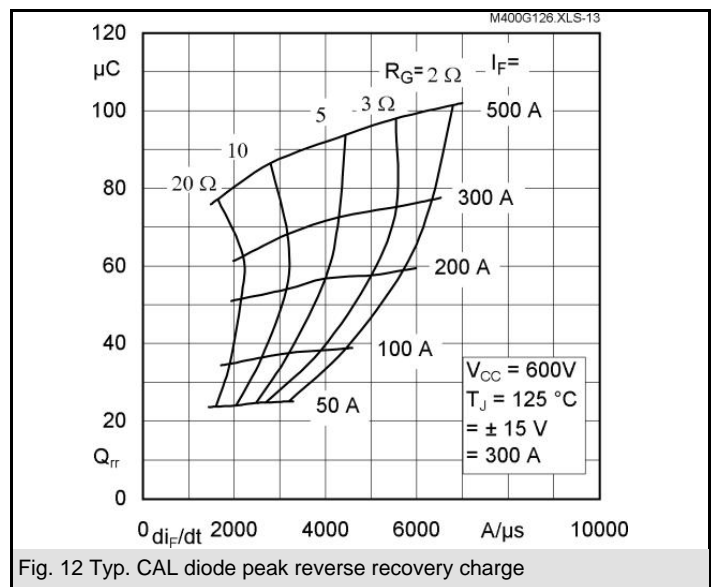
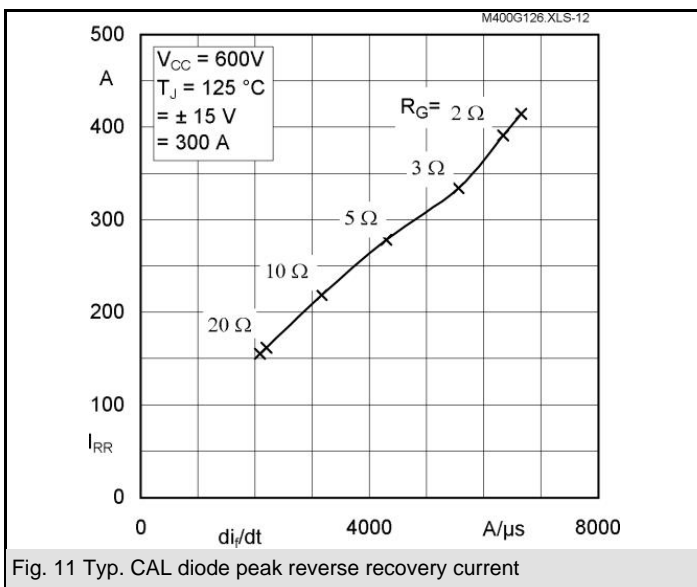
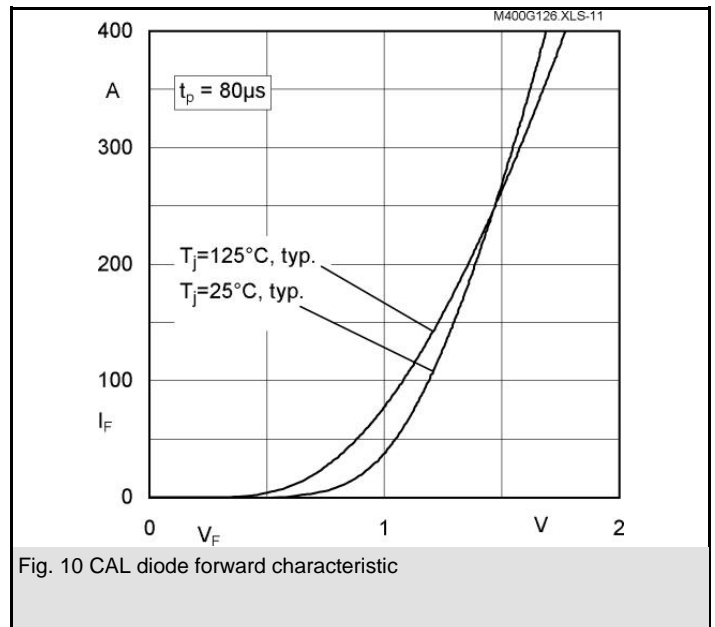
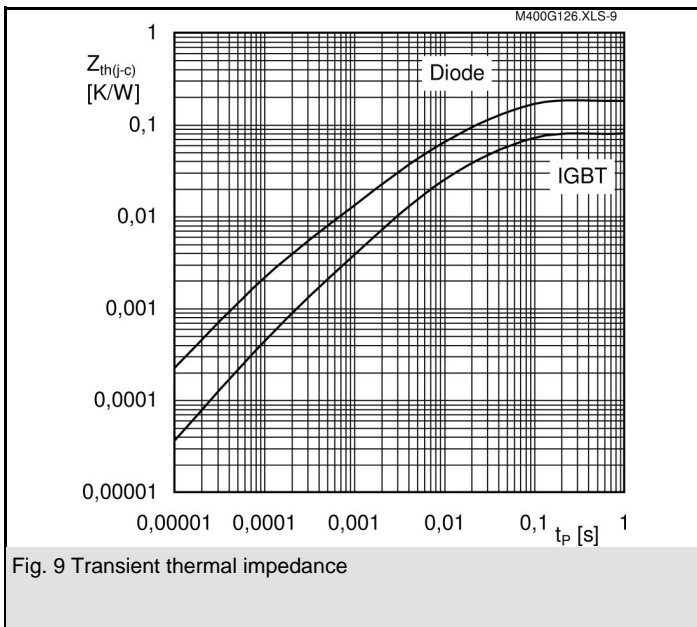
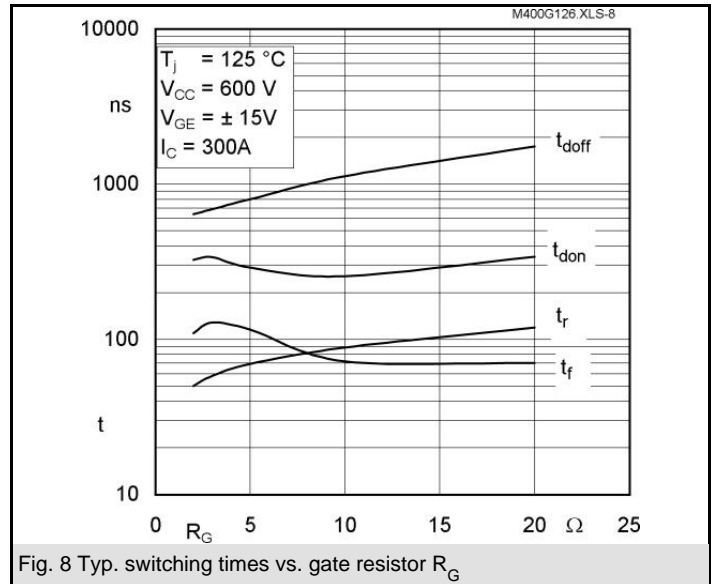
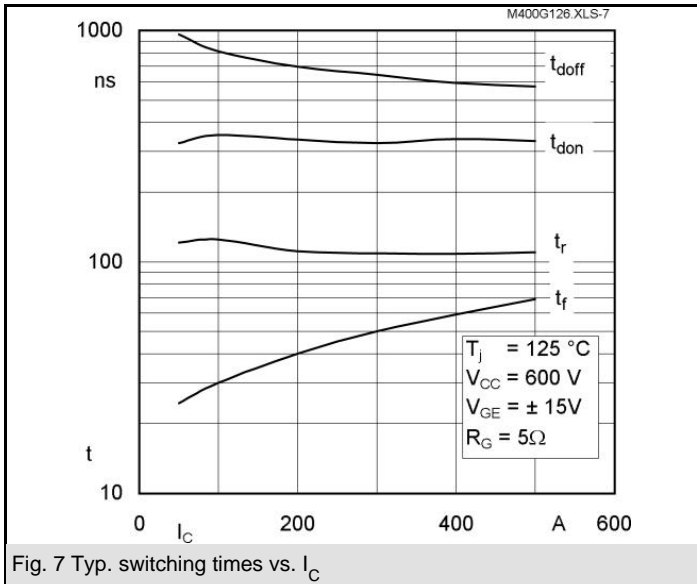

SKM 400GB126D ...

UL Recognized
File no. E 63 532

Dimensions in mm

CASED56

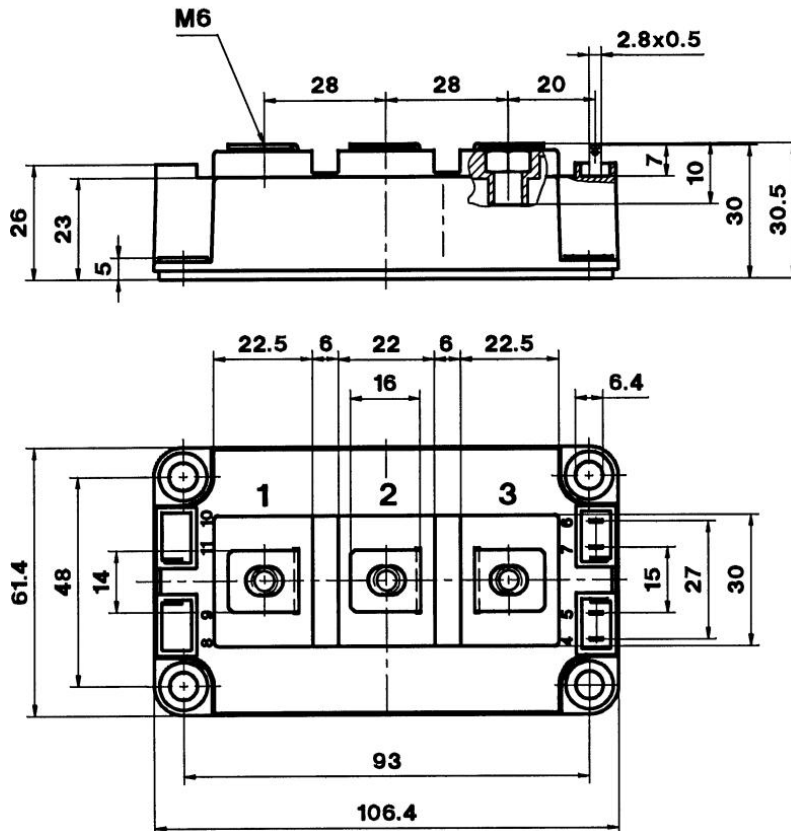

Case D 56

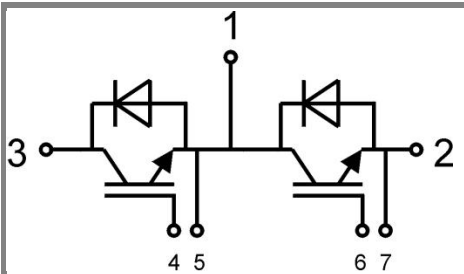

GB Case D 56

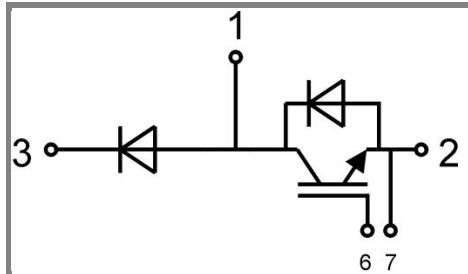

GAL Case D 57 (→ D 56)