

# SPECIFICATION

Device Name : IGBT Module

---

Type Name : 4MBI100T-060

---

Spec. No. : MS5F 5431

---

This is intended to be used as a reference only. The products of  
 Fuji Electric Co., Ltd. may be subject to change without notice.  
 For the latest information, please refer to the product manual.  
 Inquiries should be made to the sales office or the nearest branch office.  
 The copyright © 2003 of Fuji Electric Co., Ltd.

Fuji Electric Co., Ltd.  
Matsumoto Factory

	DATE	NAME	APPROVED	<b>Fuji Electric Co., Ltd.</b>		
DRAWN	Apr. 23 '03	S.Ogawa	T.Fujihira	DWG NO	MS5F 5431	1 /
CHECKED	Apr. 23 '03	T.Miyasaka				14
	Apr. 23 '03	K.Yamada				



# 4MBI100T-060

## 1. Outline Drawing ( Unit : mm )

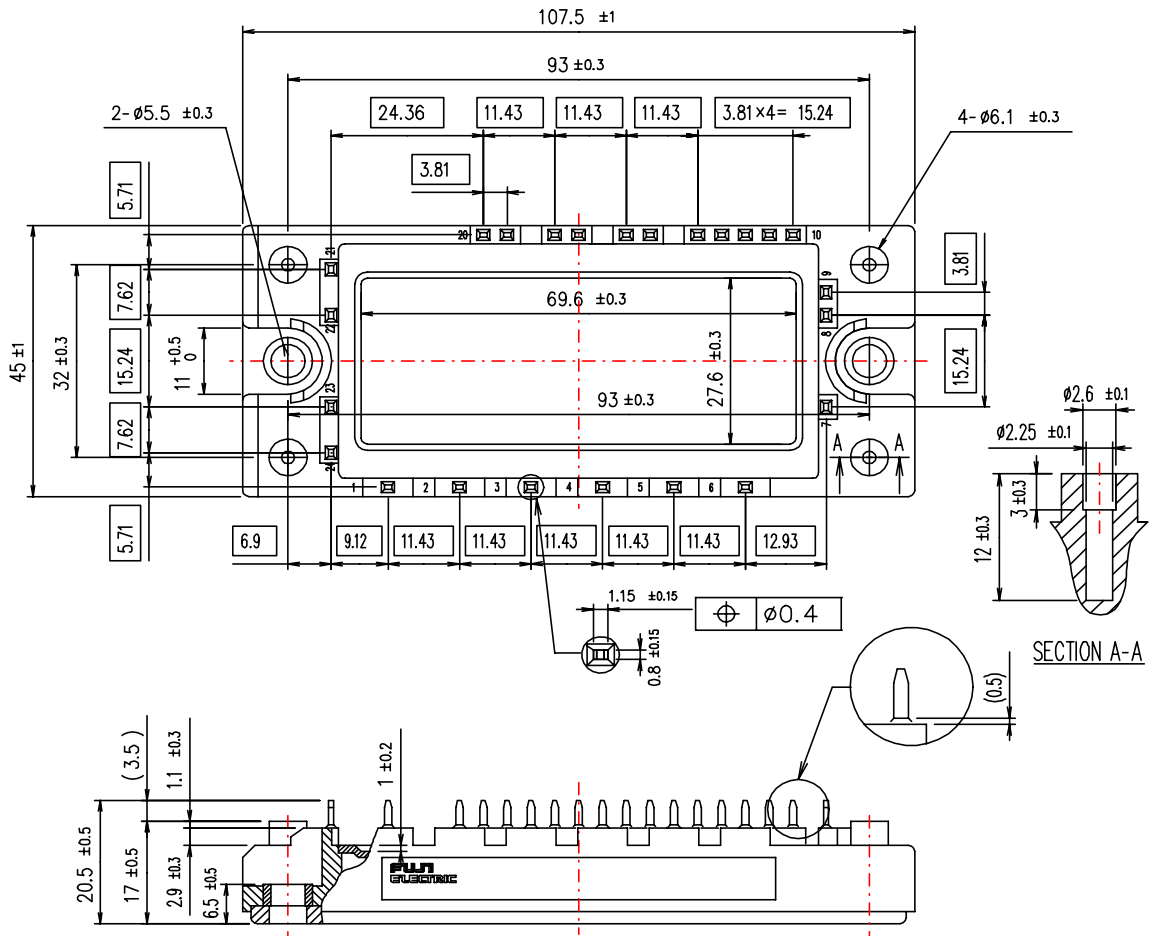

This is a preliminary drawing. The properties of each part can not be guaranteed. The properties of the product will be subject to change without notice. The user should refer to the latest drawing for the properties of the product.

— shows theoretical dimension.

- - - shows reference dimension.

## 2. Equivalent circuit

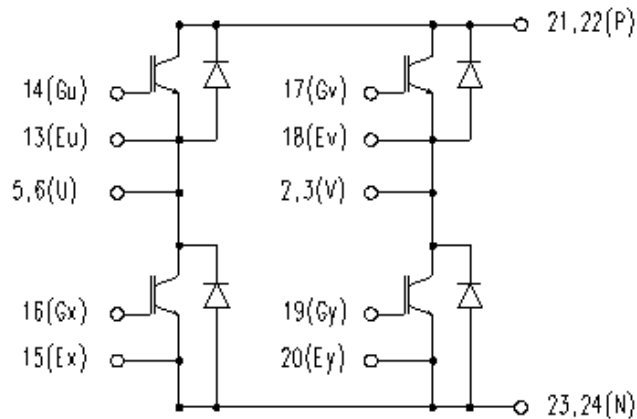

3. Absolute Maximum Ratings ( at Tc= 25°C unless otherwise specified )

Items	Symbols	Conditions	Maximum Ratings	Units
Collector-Emitter voltage	VCES	Ic=1mA	600	V
Gate-Emitter voltage	VGES		±20	V
Collector current	Ic	Duty=100 %	100	A
	Ic pulse	1ms	200	
	IF	Duty=50 %	100	
	IF pulse	1ms	200	
Collector Power Dissipation	Pc	1 device	310	W
Junction temperature	Tj		150	°C
Storage temperature	Tstg		-40~ +125	°C
Isolation voltage <sup>(*)</sup>	Viso	AC : 1min.	2500	V
Screw Torque	Mounting <sup>(*)</sup>		3.5	N·m

(\*1) All terminals should be connected together when isolation test will be done.

(\*2) Recommendable Value : Mounting 2.5~3.5 N·m (M5)

4. Electrical characteristics ( at Tj= 25°C unless otherwise specified )

Items	Symbols	Conditions	Characteristics			Units	
			min.	typ.	Max.		
Zero gate voltage Collector current	ICES	VGE = 0 V, VCE = 600 V	-	-	1.0	mA	
Gate-Emitter leakage current	IGES	VCE = 0 V, VGE = ±20 V	-	-	200	nA	
Gate-Emitter threshold voltage	VGE(th)	VCE = 20 V, Ic = 100 mA	6.2	6.7	7.7	V	
Collector-Emitter saturation voltage	VCE(sat)	VGE = 15 V Ic = 100 A	Chip	-	1.8	2.2	V
			Terminal	-	2.1	2.5	
Input capacitance	Cies	VGE = 0 V	-	8500	-	pF	
Output capacitance	Coes	VCE = 10 V	-	1500	-		
Reverse transfer capacitance	Cres	f = 1 MHz	-	1300	-		
Turn-on time	ton	Vcc = 300 V	-	0.4	1.2	μs	
	tr	Ic = 100 A	-	0.25	0.6		
	tr(i)	VGE = ±15 V	-	0.1	-		
Turn-off time	toff	RG = 33 Ω	-	0.4	1.2		
	tf		-	0.04	0.45		
Forward on voltage	VF	IF = 100 A	Chip	-	1.7		2.2
			Terminal	-	2.0	2.5	
Reverse recovery time	trr	IF = 100 A	-	-	0.3	μs	
Allowable avalanche energy during short circuit cutting off (Non-repetitive)	PAV	Ic > 200A, Tj = 125°C	55	-	-	mJ	

5. Thermal resistance characteristics

Items	Symbols	Conditions	Characteristics			Units
			min.	typ.	Max.	
Thermal resistance (1 device)	Rth(j-c)	IGBT	-	-	0.400	°C/W
		FWD	-	-	1.02	
Contact Thermal resistance	Rth(c-f)	With thermal compound *	-	0.05	-	

\* This is the value which is defined mounting on the additional cooling fin with thermal compound.

This is preliminary data. The product is not recommended for use in any applications without the approval of Fuji Electric Co., Ltd.

6. Indication on module

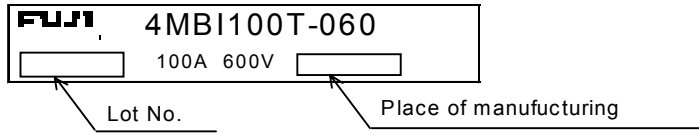

7. Applicable category

This specification is applied to IGBT Module named 4MBI100T-060

8. Storage and transportation notes

- The module should be stored at a standard temperature of 5 to 35°C and humidity of 45 to 75% .
- Store modules in a place with few temperature changes in order to avoid condensation on the module surface.
- Avoid exposure to corrosive gases and dust.
- Avoid excessive external force on the module.
- Store modules with unprocessed terminals.
- Do not drop or otherwise shock the modules when transporting.

9. Definitions of switching time

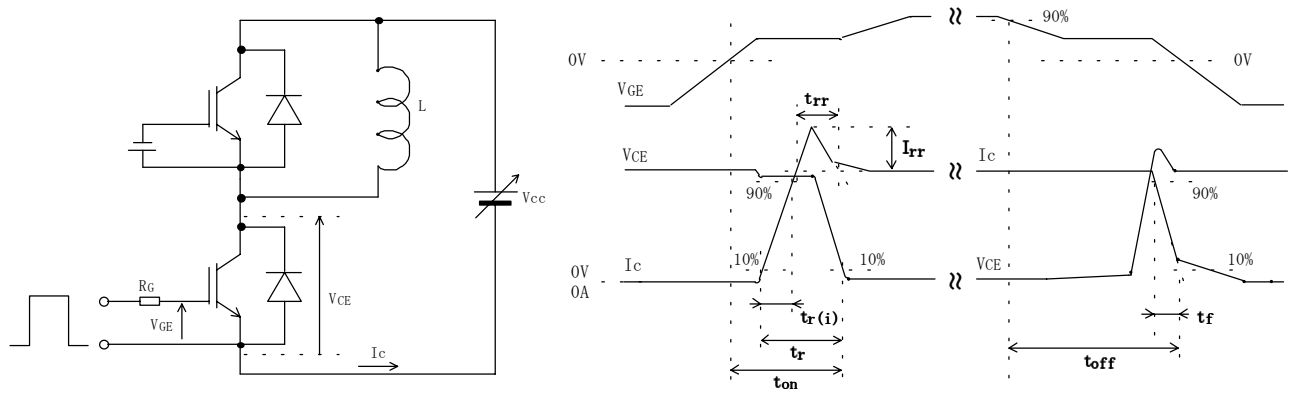

This is a preliminary specification. The product of this specification can not be used for the purpose of design. The product of this specification can not be used for the purpose of design. The product of this specification can not be used for the purpose of design.

10. Definition of the allowable avalanche energy during short circuit cutting off

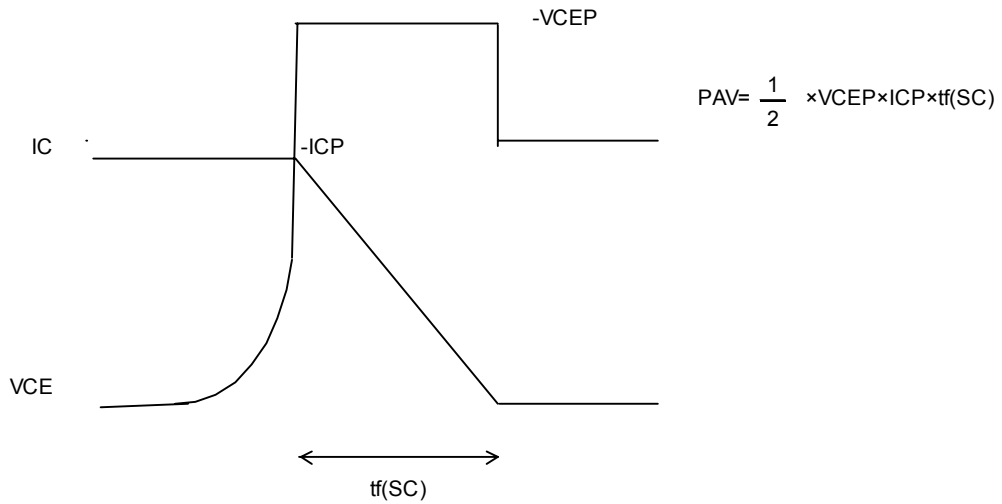

11. UL recognition

This products is recognized by Underwriters Laboratories Inc., the file No. is E82988.

12. Packing and Labeling

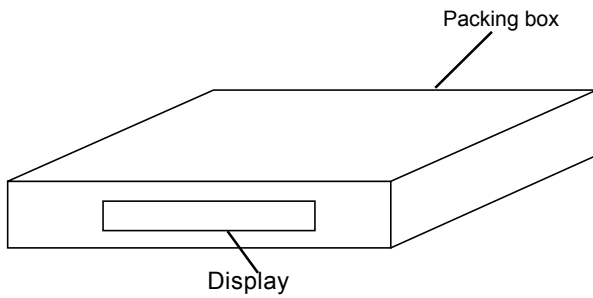

Display on the packing box

- Logo of production
- Type name
- Lot No.
- Products quantity in a packing box

\* Each modules are packed with electrical protection.

This is a preliminary drawing. The product of this drawing can not be used for the production of the product without the approval of Fuji Electric Co. Ltd.



## Reliability Test Items

Test categories	Test items	Test methods and conditions	Reference norms EIAJ ED-4701 (Aug.-2001 edition)	Number of sample	Acceptance number
Endurance Tests	1 High temperature Reverse Bias	Test temp. : $T_a = 125 \pm 5 \text{ }^\circ\text{C}$ ( $T_j \leq 150 \text{ }^\circ\text{C}$ ) Bias Voltage : $V_C = 0.8 \times V_{CES}$ Bias Method : Applied DC voltage to C-E $V_{GE} = 0V$ Test duration : 1000hr.	Test Method 101	5	( 1 : 0 )
	2 High temperature Bias (for gate)	Test temp. : $T_a = 125 \pm 5 \text{ }^\circ\text{C}$ ( $T_j \leq 150 \text{ }^\circ\text{C}$ ) Bias Voltage : $V_C = V_{GE} = +20V$ or $-20V$ Bias Method : Applied DC voltage to G-E $V_{CE} = 0V$ Test duration : 1000hr.	Test Method 101	5	( 1 : 0 )
	3 Temperature Humidity Bias	Test temp. : $85 \pm 2 \text{ }^\circ\text{C}$ Relative humidity : $85 \pm 5\%$ Bias Voltage : $V_C = 0.8 \times V_{CES}$ Bias Method : Applied DC voltage to C-E $V_{GE} = 0V$ Test duration : 1000hr.	Test Method 102 Condition code C	5	( 1 : 0 )
	4 Intermitted Operating Life (Power cycle) ( for IGBT )	ON time : 2 sec. OFF time : 18 sec. Test temp. : $\Delta T_j = 100 \pm 5 \text{ deg}$ $T_j \leq 150 \text{ }^\circ\text{C}$ , $T_a = 25 \pm 5 \text{ }^\circ\text{C}$ Number of cycles : 15000 cycles	Test Method 106	5	( 1 : 0 )

## Failure Criteria

Item	Characteristic	Symbol	Failure criteria		Unit	Note
			Lower limit	Upper limit		
Electrical characteristic	Leakage current	ICES	-	USL×2	mA	
		±IGES	-	USL×2	μA	
	Gate threshold voltage	V <sub>GE(th)</sub>	LSL×0.8	USL×1.2	mA	
	Saturation voltage	V <sub>CE(sat)</sub>	-	USL×1.2	V	
	Forward voltage	V <sub>F</sub>	-	USL×1.2	V	
	Thermal resistance	IGBT	ΔV <sub>GE</sub>	-	USL×1.2	mV
or ΔV <sub>CE</sub>						
	FWD	ΔV <sub>F</sub>	-	USL×1.2	mV	
	Isolation voltage	Viso	Broken insulation		-	
Visual inspection	Visual inspection Peeling Plating and the others	-	The visual sample		-	

LSL : Lower specified limit.

USL : Upper specified limit.

Note : Each parameter measurement read-outs shall be made after stabilizing the components at room ambient for 2 hours minimum, 24 hours maximum after removal from the tests. And in case of the wetting tests, for example, moisture resistance tests, each component shall be made wipe or dry completely before the measurement.



## Reliability Test Results

Test categories	Test items	Reference norms EIAJ ED-4701 (Aug.-2001 edition)	Number of test sample	Number of failure sample
Mechanical Tests	1 Terminal Strength (Pull test)	Test Method 401 Method I	5	0
	2 Mounting Strength	Test Method 402 method II	5	0
	3 Vibration	Test Method 403 Condition code B	5	0
	4 Shock	Test Method 404 Condition code B	5	0
	5 Solderability	Test Method 303 Condition code A	5	0
	6 Resistance to Soldering Heat	Test Method 302 Condition code A	5	0
Environment Tests	1 High Temperature Storage	Test Method 201	5	0
	2 Low Temperature Storage	Test Method 202	5	0
	3 Temperature Humidity Storage	Test Method 103 Test code C	5	0
	4 Unsaturated Pressure Cooker	Test Method 103 Test code E	5	0
	5 Temperature Cycle	Test Method 105	5	0
	6 Thermal Shock	Test Method 307 method I Condition code A	5	0
Endurance Tests	1 High temperature Reverse Bias	Test Method 101	5	0
	2 High temperature Bias ( for gate )	Test Method 101	5	0
	3 Temperature Humidity Bias	Test Method 102 Condition code C	5	0
	4 Intermitted Operating Life (Power cycling) ( for IGBT )	Test Method 106	5	0

This is intended to be a guide only. The presence of  
 lead pins on the top of the package is not a requirement for  
 the package to be used in the assembly. The use of any  
 materials or assembly methods not specified by the package  
 manufacturer is the responsibility of the user.

This is preliminary data and does not constitute a contract. The properties of  
 individual lots may vary and the manufacturer assumes no responsibility for  
 any loss or damage caused by the use of any  
 information or data contained in this document without  
 the express written consent of Fuji Electric Co., Ltd.

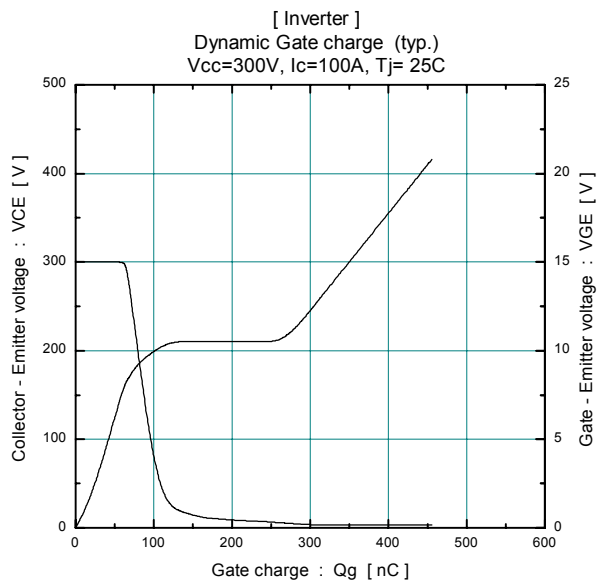
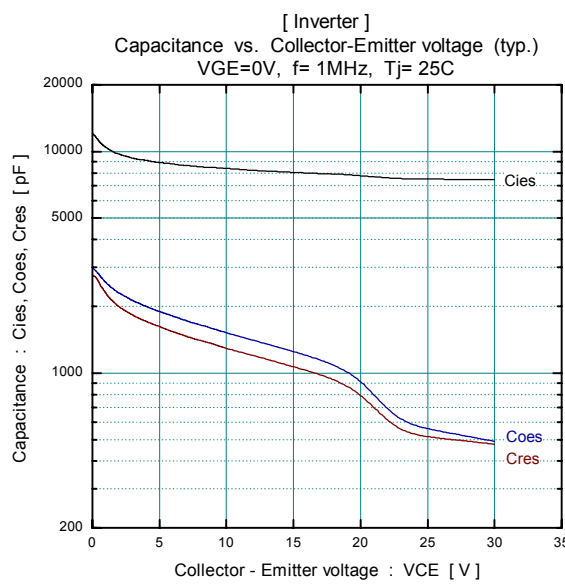
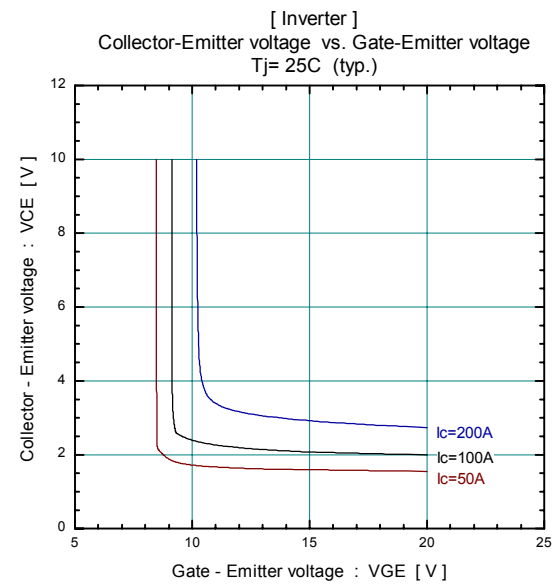
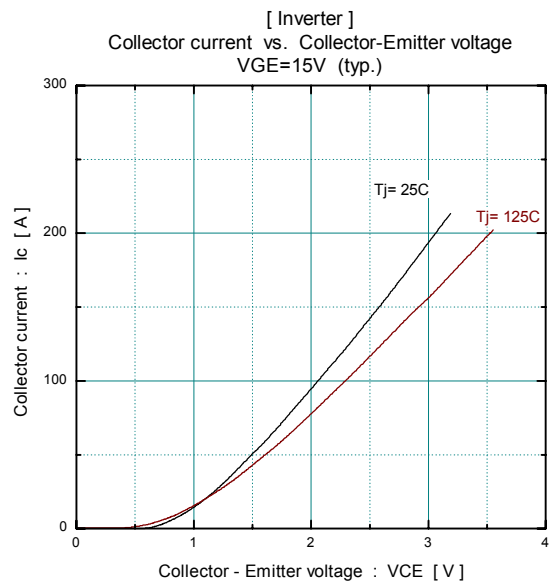
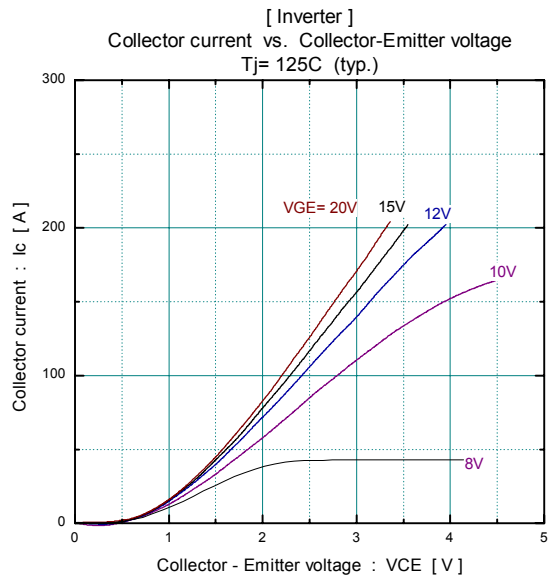
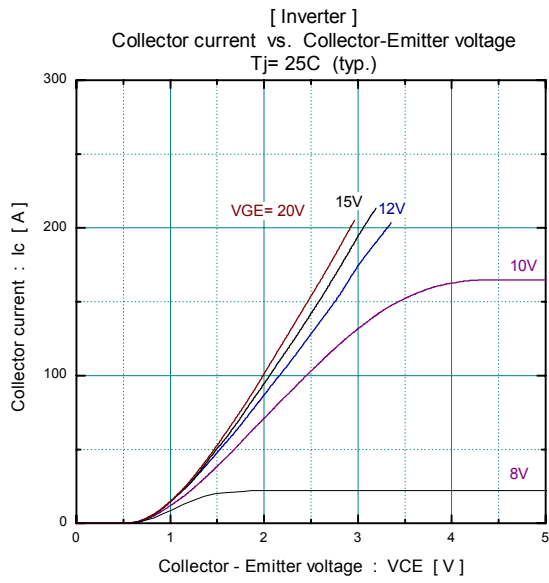

This is preliminary data and is not guaranteed. The properties of each device can differ and will be subject to normal manufacturing tolerances. Please refer to the data sheet for the use of any information essential to the safe operation of the device without the express written consent of Fuji Electric Co., Ltd.

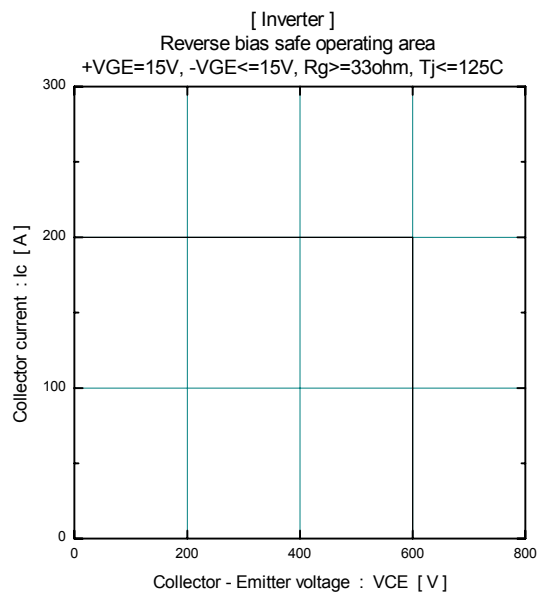
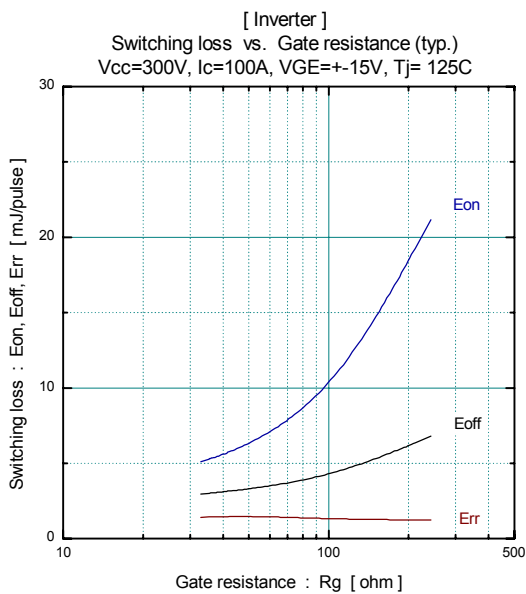
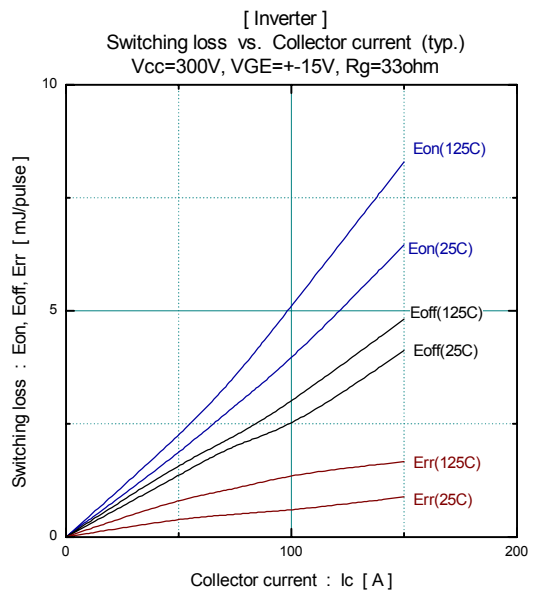
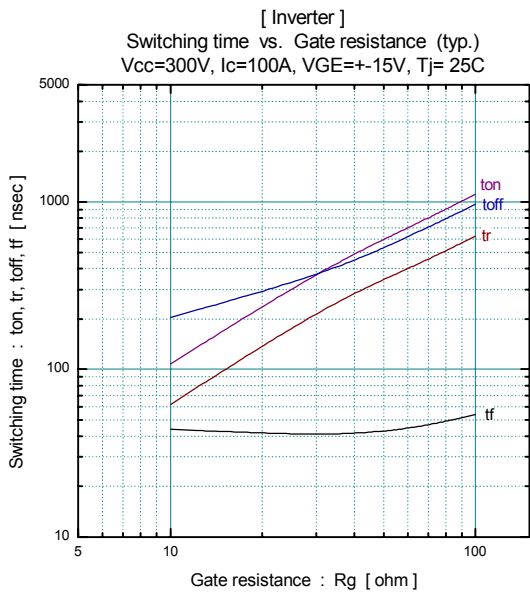
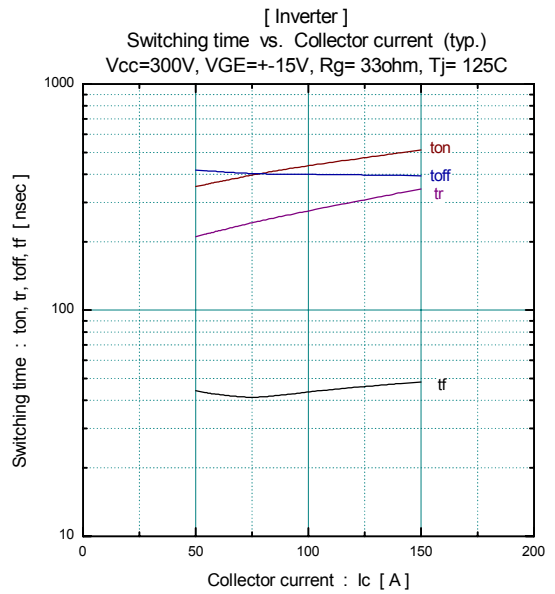
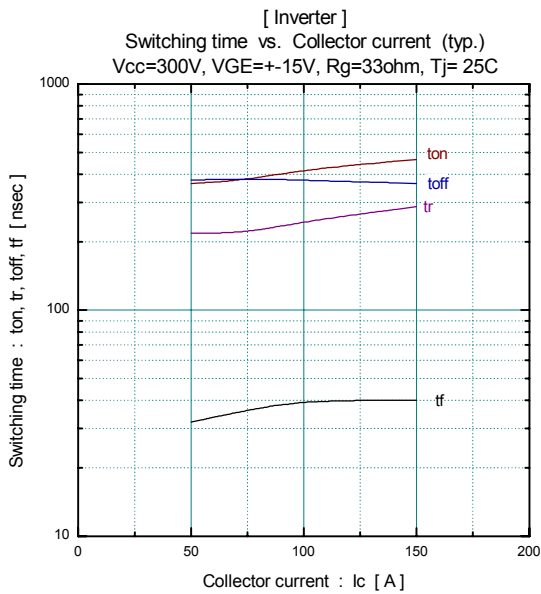

This is preliminary data and is subject to change without notice. The properties of  
 individual lots may differ from the typical values. The properties of individual lots  
 may differ from the typical values. The properties of individual lots may differ from  
 the typical values. The properties of individual lots may differ from the typical  
 values. The properties of individual lots may differ from the typical values.

[ Inverter ]  
Forward current vs. Forward on voltage (typ.)

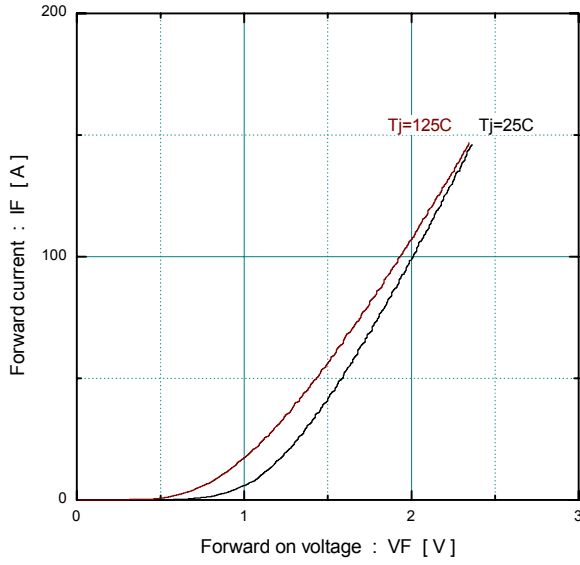

[ Inverter ]  
Reverse recovery characteristics (typ.)  
Vcc=300V, VGE=+-15V, Rg=33ohm

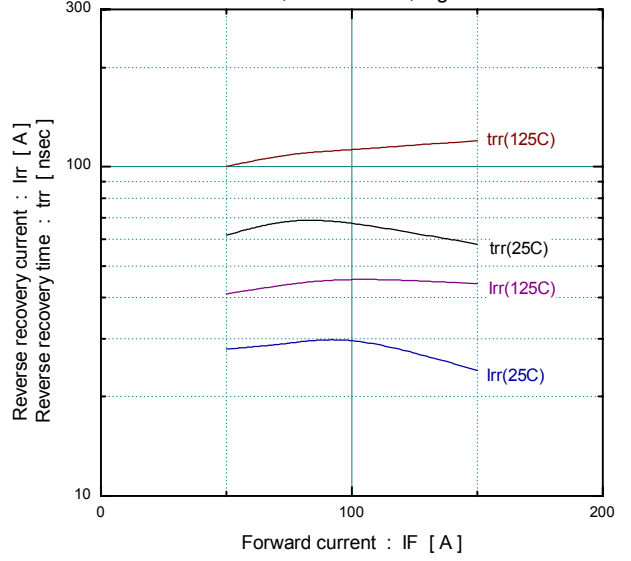

Transient thermal resistance

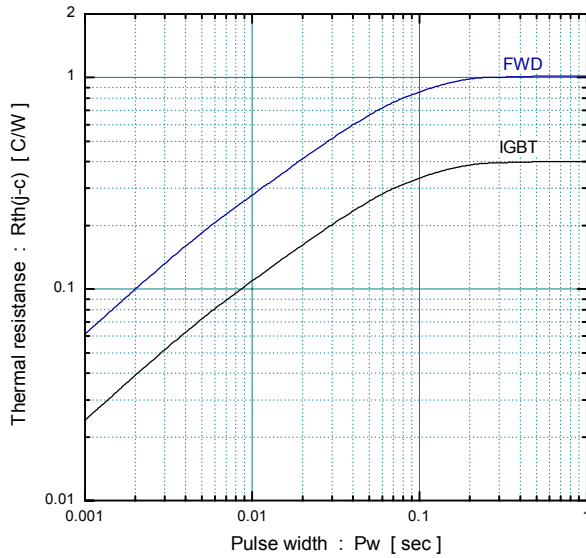

## Warnings

- This product shall be used within its absolute maximum rating (voltage, current, and temperature).  
This product may be broken in case of using beyond the ratings.  
製品の絶対最大定格(電圧, 電流, 温度等)の範囲内で御使用下さい。  
絶対最大定格を超えて使用すると、素子が破壊する場合があります。
- Connect adequate fuse or protector of circuit between three-phase line and this product to prevent the equipment from causing secondary destruction.  
万一の不慮の事故で素子が破壊した場合を考慮し、商用電源と本製品の間に適切な容量のヒューズ又はブレーカーを必ず付けて2次破壊を防いでください。
- Use this product after realizing enough working on environment and considering of product's reliability life.  
This product may be broken before target life of the system in case of using beyond the product's reliability life.  
製品の使用環境を十分に把握し、製品の信頼性寿命が満足できるか検討の上、本製品を適用して下さい。  
製品の信頼性寿命を超えて使用した場合、装置の目標寿命より前に素子が破壊する場合があります。
- If the product had been used in the environment with acid, organic matter, and corrosive gas ( hydrogen sulfide, sulfurous acid gas), the product's performance and appearance can not be ensured easily.  
酸・有機物・腐食性ガス(硫化水素, 亜硫酸ガス等)を含む環境下で使用された場合、製品機能・外観などの保証は致しかねます。
- Use this product within the power cycle curve (Technical Rep.No. : MT6M3947)  
本製品は、パワーサイクル寿命カーブ以下で使用下さい(技術資料No.: MT6M3947)
- Never add mechanical stress to deform the main or control terminal.  
The deformed terminal may cause poor contact problem.  
主端子及び制御端子に応力を与えて変形させないで下さい。 端子の変形により、接触不良などを引き起こす場合があります。
- Use this product with keeping the cooling fin's flatness between screw holes within 100um at 100mm and the roughness within 10um. Also keep the tightening torque within the limits of this specification.  
Improper handling may cause isolation breakdown and this may lead to a critical accident.  
冷却フィンにネジ取り付け位置間で平坦度を100mmで100um以下、表面の粗さは10um以下にして下さい。 誤った取り扱いをすると絶縁破壊を起こし、重大事故に発展する場合があります。
- It shall be confirmed that IGBT's operating locus of the turn-off voltage and current are within the RBSOA specification. This product may be broken if the locus is out of the RBSOA.  
ターンオフ電圧・電流の動作軌跡がRBSOA仕様内にあることを確認して下さい。  
RBSOAの範囲を超えて使用すると素子が破壊する可能性があります。
- If excessive static electricity is applied to the control terminals, the devices may be broken.  
Implement some countermeasures against static electricity.  
制御端子に過大な静電気が印加された場合、素子が破壊する場合があります。  
取り扱い時は静電気対策を実施して下さい。
- Never add the excessive mechanical stress to the main or control terminals when the product is applied to equipments. The module structure may be broken.  
素子を装置に実装する際に、主端子や制御端子に過大な応力を与えないで下さい。  
端子構造が破壊する可能性があります。
- In case of insufficient -VGE, erroneous turn-on of IGBT may occur.  
-VGE shall be set enough value to prevent this malfunction. (Recommended value : -VGE = -15V)  
逆バイアスゲート電圧-VGEが不足しますと誤点弧を起こす可能性があります。  
誤点弧を起こさない為に-VGEは十分な値で設定して下さい。(推奨値 : -VGE = -15V)
- In case of higher turn-on dv/dt of IGBT, erroneous turn-on of opposite arm IGBT may occur.  
Use this product in the most suitable drive conditions, such as +VGE, -VGE, RG to prevent the malfunction.  
ターンオン dv/dt が高いと対抗アームのIGBTが誤点弧を起こす可能性があります。  
誤点弧を起こさない為の最適なドライブ条件(+VGE, -VGE, RG等)でご使用下さい。

This is a preliminary drawing. The product of this type can not be guaranteed to be identical to the product of the same type in the future without the approval of Fuji Electric Co. Ltd.

## Cautions

- Fuji Electric is constantly making every endeavor to improve the product quality and reliability. However, semiconductor products may rarely happen to fail or malfunction. To prevent accidents causing injury or death, damage to property like by fire, and other social damage resulted from a failure or malfunction of the Fuji Electric semiconductor products, take some measures to keep safety such as redundant design, spread-fire-preventive design, and malfunction-protective design.

富士電機は絶えず製品の品質と信頼性の向上に努めています。しかし、半導体製品は故障が発生したり、誤動作する場合があります。富士電機製半導体製品の故障または誤動作が、結果として人身事故・火災等による財産に対する損害や社会的な損害を起こさないように冗長設計・延焼防止設計・誤動作防止設計など安全確保のための手段を講じて下さい。

- The application examples described in this specification only explain typical ones that used the Fuji Electric products. This specification never ensure to enforce the industrial property and other rights, nor license the enforcement rights.

本仕様書に記載してある応用例は、富士電機製品を使用した代表的な応用例を説明するものであり、本仕様書によって工業所有権、その他権利の実施に対する保障または実施権の許諾を行うものではありません。

- The product described in this specification is not designed nor made for being applied to the equipment or systems used under life-threatening situations. When you consider applying the product of this specification to particular used, such as vehicle-mounted units, shipboard equipment, aerospace equipment, medical devices, atomic control systems and submarine relaying equipment or systems, please apply after confirmation of this product to be satisfied about system construction and required reliability.

本仕様書に記載された製品は、人命にかかわるような状況下で使用される機器あるいはシステムに用いられることを目的として設計・製造されたものではありません。本仕様書の製品を車両機器、船舶、航空宇宙、医療機器、原子力制御、海底中継機器あるいはシステムなど、特殊用途へのご利用をご検討の際は、システム構成及び要求品質に満足することをご確認の上、ご利用下さい。

If there is any unclear matter in this specification, please contact Fuji Electric Co.,Ltd.

This is a preliminary drawing. The product of this drawing can not be used for any purpose without the approval of Fuji Electric Co., Ltd.