

MITSUBISHI IGBT MODULES
CM150DY-34A

HIGH POWER SWITCHING USE

CM150DY-34A



- IC 150A
- VCES 1700V
- Insulated Type
- 2-elements in a pack

APPLICATION

General purpose inverters & Servo controls, etc

OUTLINE DRAWING & CIRCUIT DIAGRAM

Dimensions in mm

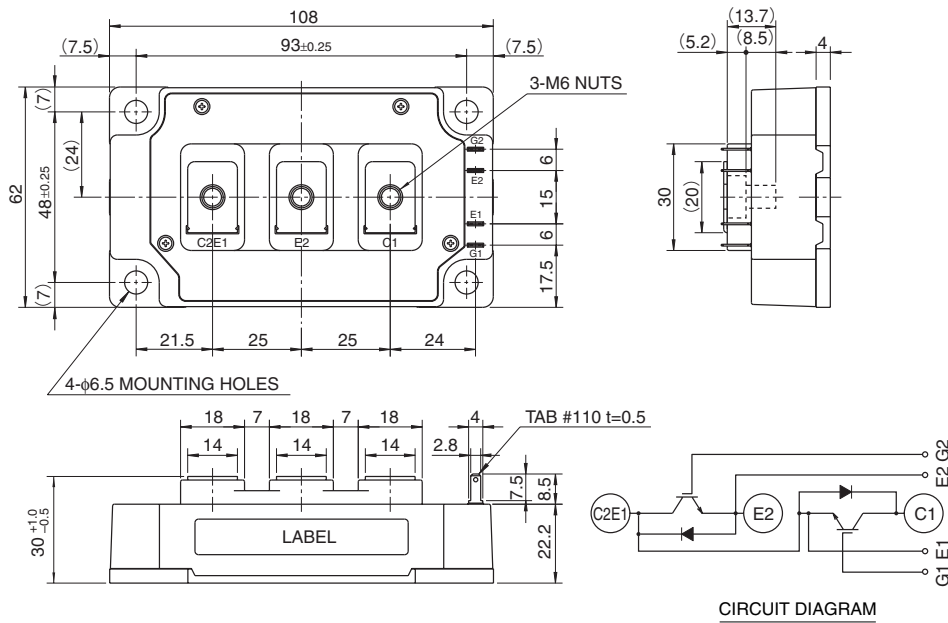

CM150DY-34A

HIGH POWER SWITCHING USE

ABSOLUTE MAXIMUM RATINGS (T_j = 25°C, unless otherwise specified)

Symbol	Parameter	Conditions	Ratings	Unit
V _{CE} S	Collector-emitter voltage	G-E Short	1700	V
V _{GE} S	Gate-emitter voltage	C-E Short	±20	V
I _C	Collector current	DC, T _c = 112°C ^{*1}	150	A
I _{CM}		Pulse	300	
I _E (Note 1)	Emitter current	Operation	150	A
I _{EM} (Note 1)		Pulse	300	
P _C (Note 3)	Maximum collector dissipation	T _c = 25°C ^{*1}	1600	W
T _j	Junction temperature		-40 ~ +150	°C
T _{stg}	Storage temperature		-40 ~ +125	°C
V _{iso}	Isolation voltage	Terminals to base plate, f = 60Hz, AC 1 minute	3500	Vrms
—	Torque strength	Main terminals M6 screw	3.5 ~ 4.5	N • m
—		Mounting M6 screw	3.5 ~ 4.5	
—	Weight	Typical value	400	g

ELECTRICAL CHARACTERISTICS (T_j = 25°C, unless otherwise specified)

Symbol	Parameter	Test conditions	Limits			Unit
			Min.	Typ.	Max.	
I _{CES}	Collector cutoff current	V _{CE} = V _{CE} S, V _{GE} = 0V	—	—	1	mA
V _{GE(th)}	Gate-emitter threshold voltage	I _C = 15mA, V _{CE} = 10V	5.5	7.0	8.5	V
I _{GES}	Gate leakage current	±V _{GE} = V _{GES} , V _{CE} = 0V	—	—	2.0	µA
V _{CE(sat)}	Collector to emitter saturation voltage	I _C = 150A, V _{GE} = 15V	T _j = 25°C		2.8	V
			T _j = 125°C		2.45	
C _{ies}	Input capacitance	V _{CE} = 10V V _{GE} = 0V	—	—	37	nF
C _{oes}	Output capacitance		—	—	4.2	
C _{res}	Reverse transfer capacitance		—	—	0.8	
Q _G	Total gate charge	V _{CC} = 1000V, I _C = 150A, V _{GE} = 15V	—	1000	—	nC
t _{d(on)}	Turn-on delay time	V _{CC} = 1000V, I _C = 150A V _{GE} = ±15V R _G = 3.2Ω, Inductive load I _E = 150A	—	—	550	ns
t _r	Turn-on rise time		—	—	190	
t _{d(off)}	Turn-off delay time		—	—	750	
t _f	Turn-off fall time		—	—	350	
t _{rr} (Note 1)	Reverse recovery time		—	—	450	
Q _{rr} (Note 1)	Reverse recovery charge	—	15	—	µC	
V _{EC} (Note 1)	Emitter-collector voltage	I _E = 150A, V _{GE} = 0V	—	—	3.0	V
R _{th(j-c)Q}	Thermal resistance	IGBT part (1/2 module) ^{*1}	—	—	0.078	K/W
R _{th(j-c)R}		FWDi part (1/2 module) ^{*1}	—	—	0.15	
R _{th(c-f)}	Contact thermal resistance	Case to heat sink, Thermal compound applied (1/2 module) ^{*1,*2}	—	0.02	—	
R _G	External gate resistance		3.2	—	32	Ω

*1 : Case temperature (T_c), heat sink temperature (T_t) measured point is just under the chips.

*2 : Typical value is measured by using thermally conductive grease of λ = 0.9[W/(m • K)].

Note 1. I_E, I_{EM}, V_{EC}, t_{rr} & Q_{rr} represent characteristics of the anti-parallel, emitter-collector free-wheel diode (FWDi).

2. Pulse width and repetition rate should be such that the device junction temperature (T_j) does not exceed T_{jmax} rating.

3. Junction temperature (T_j) should not increase beyond 150°C.

4. Pulse width and repetition rate should be such as to cause negligible temperature rise.

CM150DY-34A

HIGH POWER SWITCHING USE

PERFORMANCE CURVES

OUTPUT CHARACTERISTICS (TYPICAL)

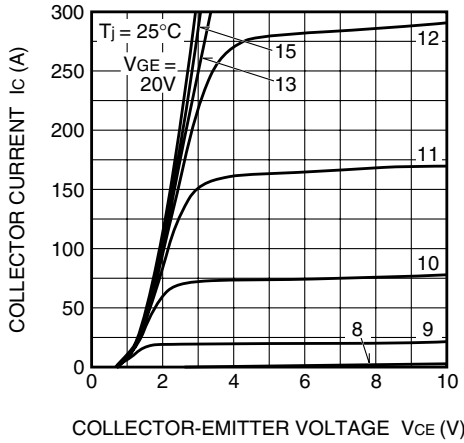

TRANSFER CHARACTERISTICS (TYPICAL)

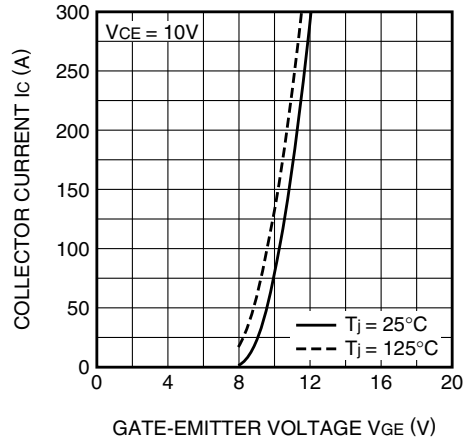

COLLECTOR-EMITTER SATURATION VOLTAGE CHARACTERISTICS (TYPICAL)

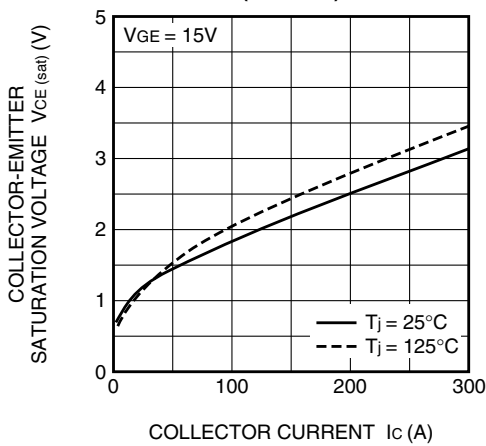

COLLECTOR-EMITTER SATURATION VOLTAGE CHARACTERISTICS (TYPICAL)

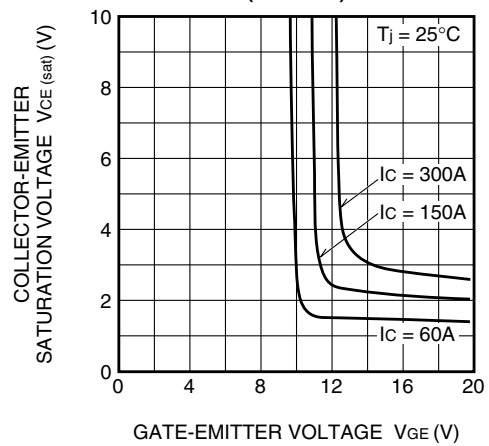

FREE-WHEEL DIODE FORWARD CHARACTERISTICS (TYPICAL)

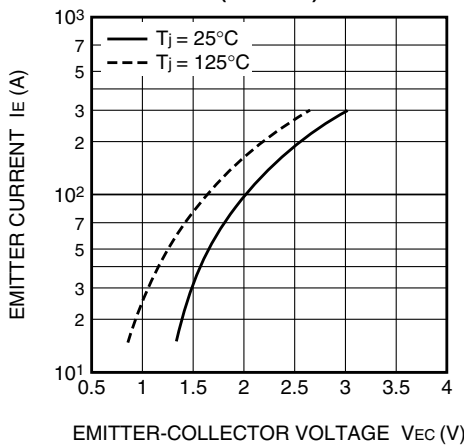

CAPACITANCE-VCE CHARACTERISTICS (TYPICAL)

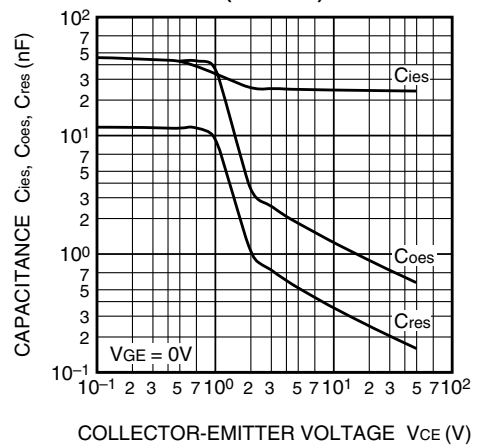

CM150DY-34A

HIGH POWER SWITCHING USE

HALF-BRIDGE SWITCHING CHARACTERISTICS
SWITCHING TIME vs. COLLECTOR CURRENT
(TYPICAL)

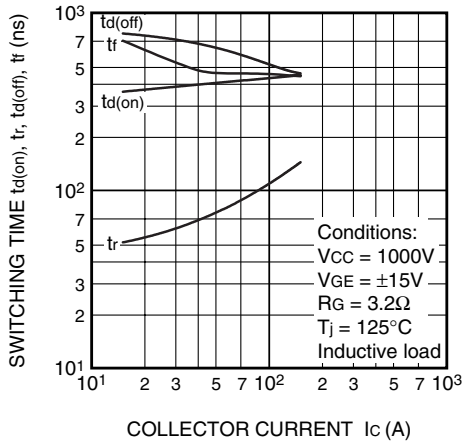

HALF-BRIDGE SWITCHING CHARACTERISTICS
SWITCHING TIME vs. GATE RESISTANCE
(TYPICAL)

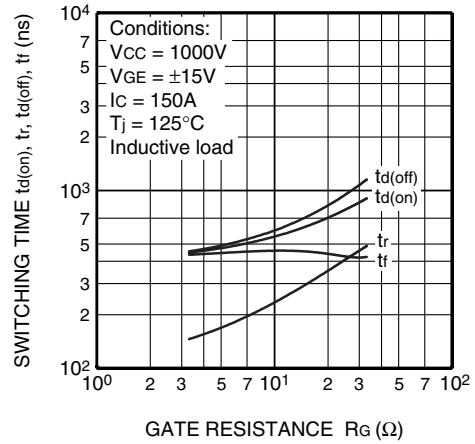

SWITCHING LOSS vs. COLLECTOR CURRENT
(TYPICAL)

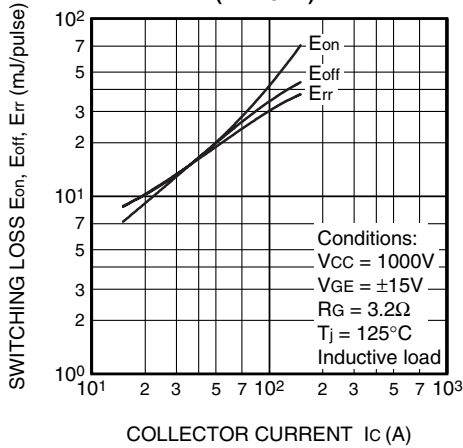

SWITCHING LOSS vs. GATE RESISTANCE
(TYPICAL)

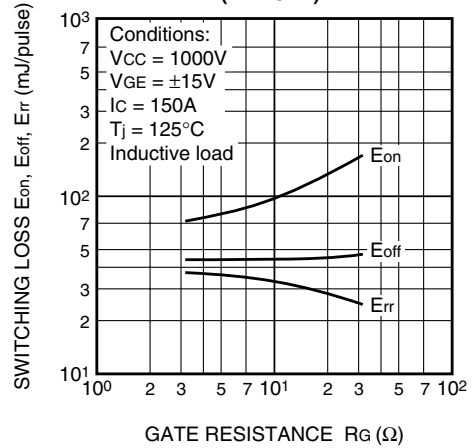

REVERSE RECOVERY CHARACTERISTICS
OF FREE-WHEEL DIODE
(TYPICAL)

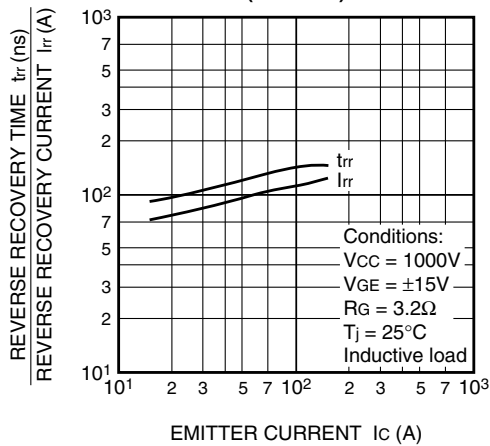

TRANSIENT THERMAL IMPEDANCE CHARACTERISTICS
(IGBT part & FWDi part)

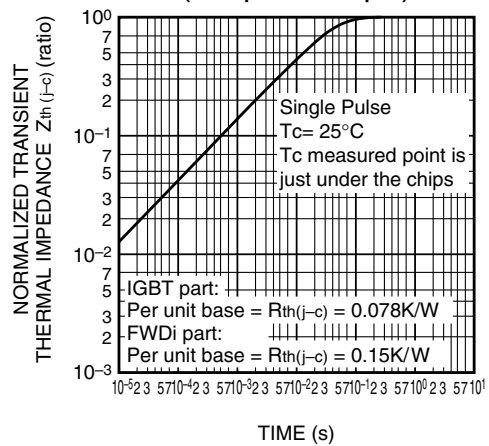

CM150DY-34A

HIGH POWER SWITCHING USE

