

MITSUBISHI IGBT MODULES  
**CM200DY-34A**

HIGH POWER SWITCHING USE

**CM200DY-34A**



- IC .....200A
- VCES ..... 1700V
- Insulated Type
- 2-elements in a pack

**APPLICATION**

General purpose inverters & Servo controls, etc

**OUTLINE DRAWING & CIRCUIT DIAGRAM**

Dimensions in mm

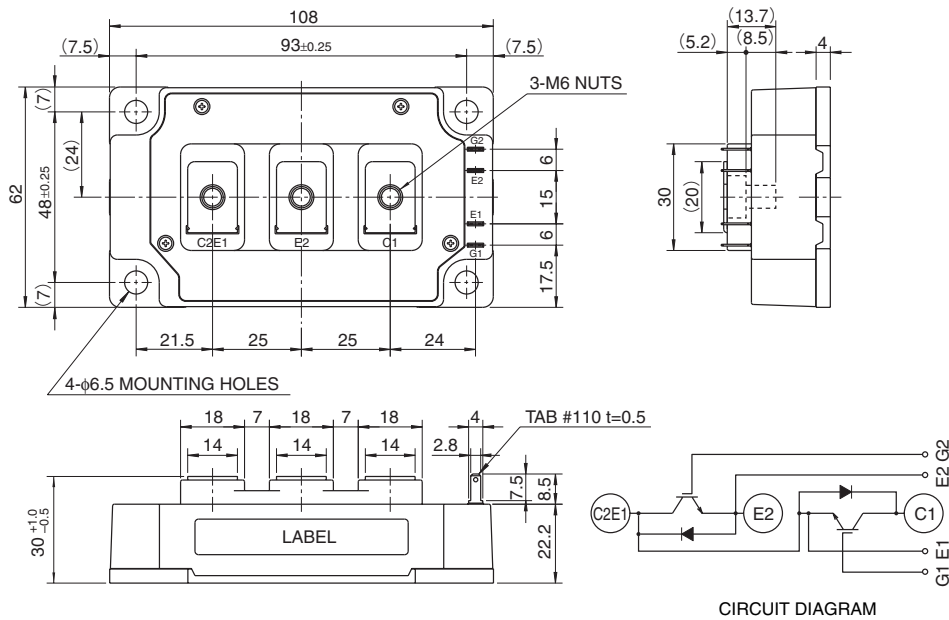

CM200DY-34A

HIGH POWER SWITCHING USE

**ABSOLUTE MAXIMUM RATINGS** (T<sub>j</sub> = 25°C, unless otherwise specified)

Symbol	Parameter	Conditions	Ratings	Unit
V <sub>CE</sub> S	Collector-emitter voltage	G-E Short	1700	V
V <sub>GE</sub> S	Gate-emitter voltage	C-E Short	±20	V
I <sub>C</sub>	Collector current	DC, T <sub>c</sub> = 109°C <sup>*1</sup>	200	A
I <sub>CM</sub>		Pulse	400	
I <sub>E</sub> (Note 1)	Emitter current	Operation	200	A
I <sub>EM</sub> (Note 1)		Pulse	400	
P <sub>C</sub> (Note 3)	Maximum collector dissipation	T <sub>c</sub> = 25°C <sup>*1</sup>	1980	W
T <sub>j</sub>	Junction temperature		-40 ~ +150	°C
T <sub>stg</sub>	Storage temperature		-40 ~ +125	°C
V <sub>iso</sub>	Isolation voltage	Terminals to base plate, f = 60Hz, AC 1 minute	3500	Vrms
—	Torque strength	Main terminals M6 screw	3.5 ~ 4.5	N • m
—		Mounting M6 screw	3.5 ~ 4.5	
—	Weight	Typical value	400	g

**ELECTRICAL CHARACTERISTICS** (T<sub>j</sub> = 25°C, unless otherwise specified)

Symbol	Parameter	Test conditions	Limits			Unit	
			Min.	Typ.	Max.		
I <sub>CE</sub> S	Collector cutoff current	V <sub>CE</sub> = V <sub>CE</sub> S, V <sub>GE</sub> = 0V	—	—	1	mA	
V <sub>GE(th)</sub>	Gate-emitter threshold voltage	I <sub>C</sub> = 20mA, V <sub>CE</sub> = 10V	5.5	7.0	8.5	V	
I <sub>GE</sub> S	Gate leakage current	±V <sub>GE</sub> = V <sub>GE</sub> S, V <sub>CE</sub> = 0V	—	—	2.0	μA	
V <sub>CE(sat)</sub>	Collector to emitter saturation voltage	I <sub>C</sub> = 200A, V <sub>GE</sub> = 15V	T <sub>j</sub> = 25°C	—	2.2	2.8	V
			T <sub>j</sub> = 125°C	—	2.45	—	
C <sub>ies</sub>	Input capacitance	V <sub>CE</sub> = 10V V <sub>GE</sub> = 0V	—	—	49.4	nF	
C <sub>oes</sub>	Output capacitance		—	—	5.6		
C <sub>res</sub>	Reverse transfer capacitance		—	—	1.06		
Q <sub>G</sub>	Total gate charge	V <sub>CC</sub> = 1000V, I <sub>C</sub> = 200A, V <sub>GE</sub> = 15V	—	1330	—	nC	
t <sub>d(on)</sub>	Turn-on delay time	V <sub>CC</sub> = 1000V, I <sub>C</sub> = 200A V <sub>GE</sub> = ±15V R <sub>G</sub> = 2.4Ω, Inductive load I <sub>E</sub> = 200A	—	—	550	ns	
t <sub>r</sub>	Turn-on rise time		—	—	190		
t <sub>d(off)</sub>	Turn-off delay time		—	—	750		
t <sub>f</sub>	Turn-off fall time		—	—	350		
t <sub>rr</sub> (Note 1)	Reverse recovery time		—	—	450		
Q <sub>rr</sub> (Note 1)	Reverse recovery charge	—	20	—	μC		
V <sub>EC</sub> (Note 1)	Emitter-collector voltage	I <sub>E</sub> = 200A, V <sub>GE</sub> = 0V	—	—	3.0	V	
R <sub>th(j-c)Q</sub>	Thermal resistance	IGBT part (1/2 module) <sup>*1</sup>	—	—	0.063	K/W	
R <sub>th(j-c)R</sub>		FWDi part (1/2 module) <sup>*1</sup>	—	—	0.11		
R <sub>th(c-f)</sub>	Contact thermal resistance	Case to heat sink, Thermal compound applied (1/2 module) <sup>*1,*2</sup>	—	0.02	—		
R <sub>G</sub>	External gate resistance		2.4	—	24	Ω	

\*1 : Case temperature (T<sub>c</sub>), heat sink temperature (T<sub>t</sub>) measured point is just under the chips.

\*2 : Typical value is measured by using thermally conductive grease of λ = 0.9[W/(m • K)].

Note 1. I<sub>E</sub>, I<sub>EM</sub>, V<sub>EC</sub>, t<sub>rr</sub> & Q<sub>rr</sub> represent characteristics of the anti-parallel, emitter-collector free-wheel diode (FWDi).

2. Pulse width and repetition rate should be such that the device junction temperature (T<sub>j</sub>) does not exceed T<sub>jmax</sub> rating.

3. Junction temperature (T<sub>j</sub>) should not increase beyond 150°C.

4. Pulse width and repetition rate should be such as to cause negligible temperature rise.

PERFORMANCE CURVES

OUTPUT CHARACTERISTICS (TYPICAL)

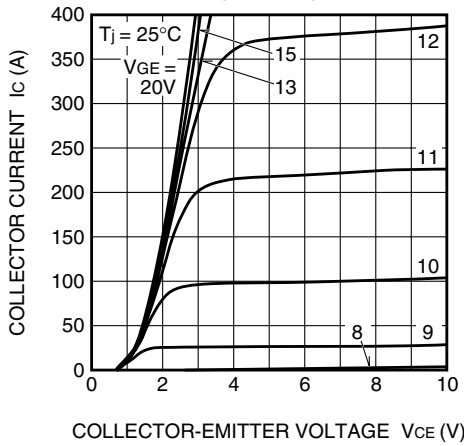

TRANSFER CHARACTERISTICS (TYPICAL)

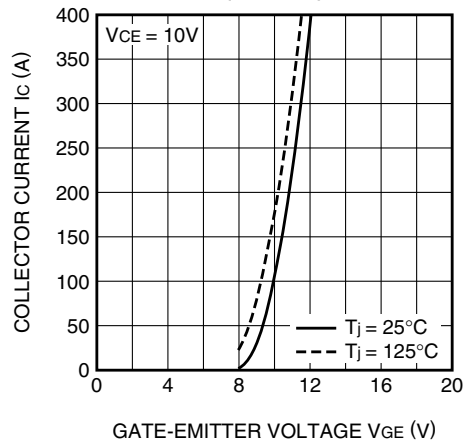

COLLECTOR-EMITTER SATURATION VOLTAGE CHARACTERISTICS (TYPICAL)

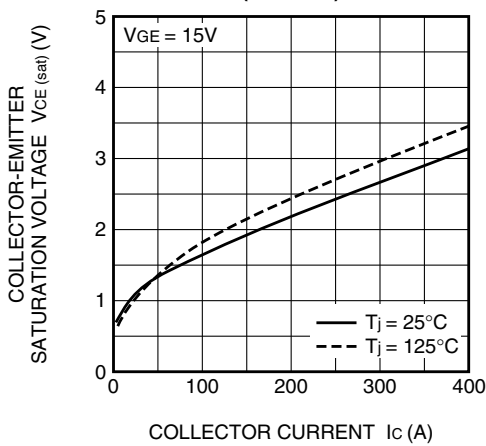

COLLECTOR-EMITTER SATURATION VOLTAGE CHARACTERISTICS (TYPICAL)

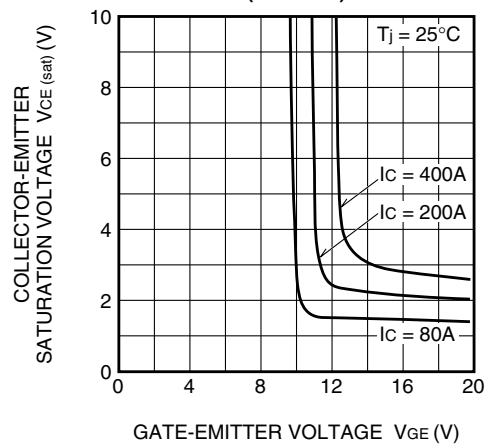

FREE-WHEEL DIODE FORWARD CHARACTERISTICS (TYPICAL)

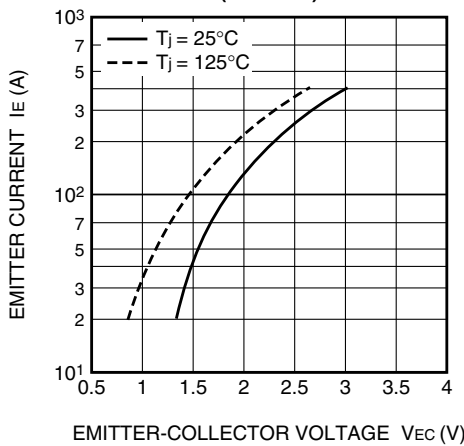

CAPACITANCE-VCE CHARACTERISTICS (TYPICAL)

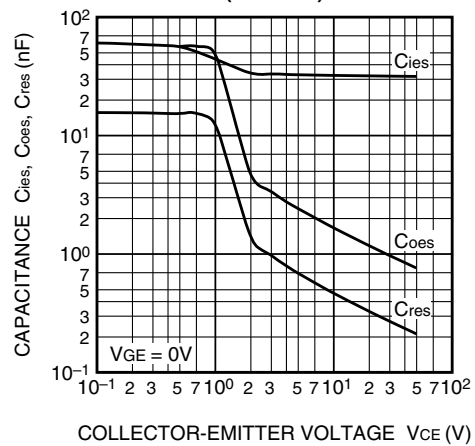

**HALF-BRIDGE SWITCHING CHARACTERISTICS SWITCHING TIME vs. COLLECTOR CURRENT (TYPICAL)**

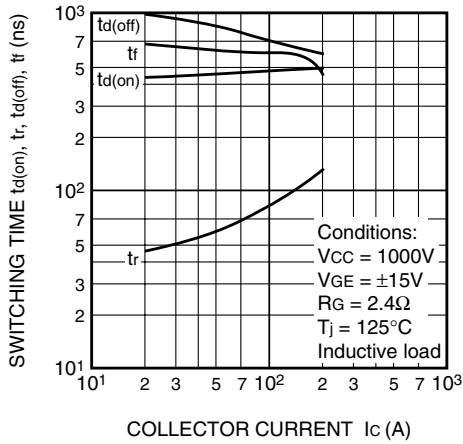

**HALF-BRIDGE SWITCHING CHARACTERISTICS SWITCHING TIME vs. GATE RESISTANCE (TYPICAL)**

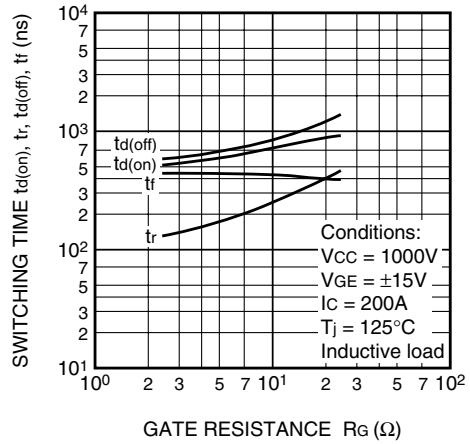

**SWITCHING LOSS vs. COLLECTOR CURRENT (TYPICAL)**

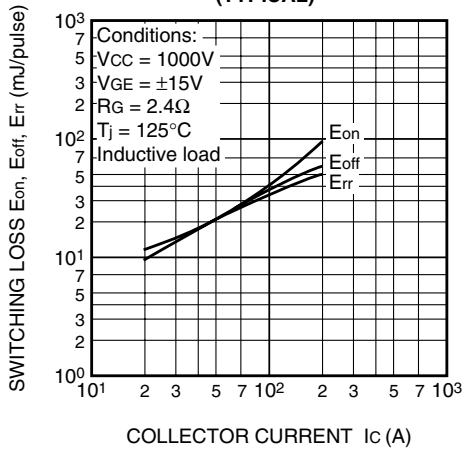

**SWITCHING LOSS vs. GATE RESISTANCE (TYPICAL)**

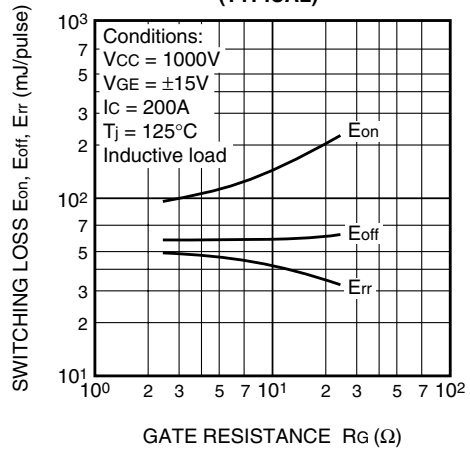

**REVERSE RECOVERY CHARACTERISTICS OF FREE-WHEEL DIODE (TYPICAL)**

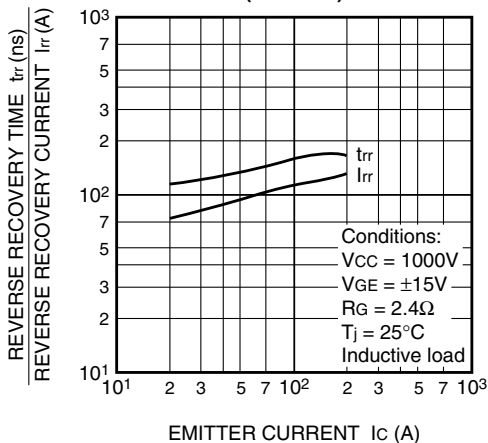

**TRANSIENT THERMAL IMPEDANCE CHARACTERISTICS (IGBT part & FWDi part)**

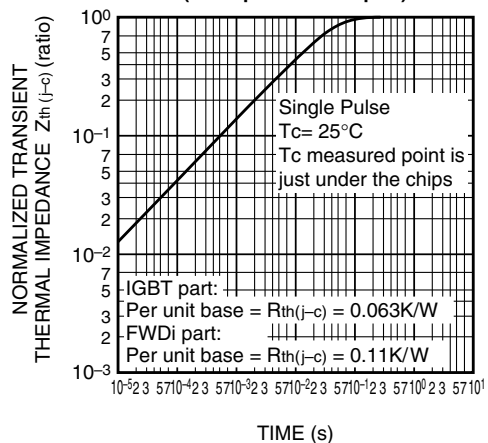

# CM200DY-34A

HIGH POWER SWITCHING USE

---

