

### Dual IGBTMOD™ KA-Series Module 300 Amperes/1700 Volts

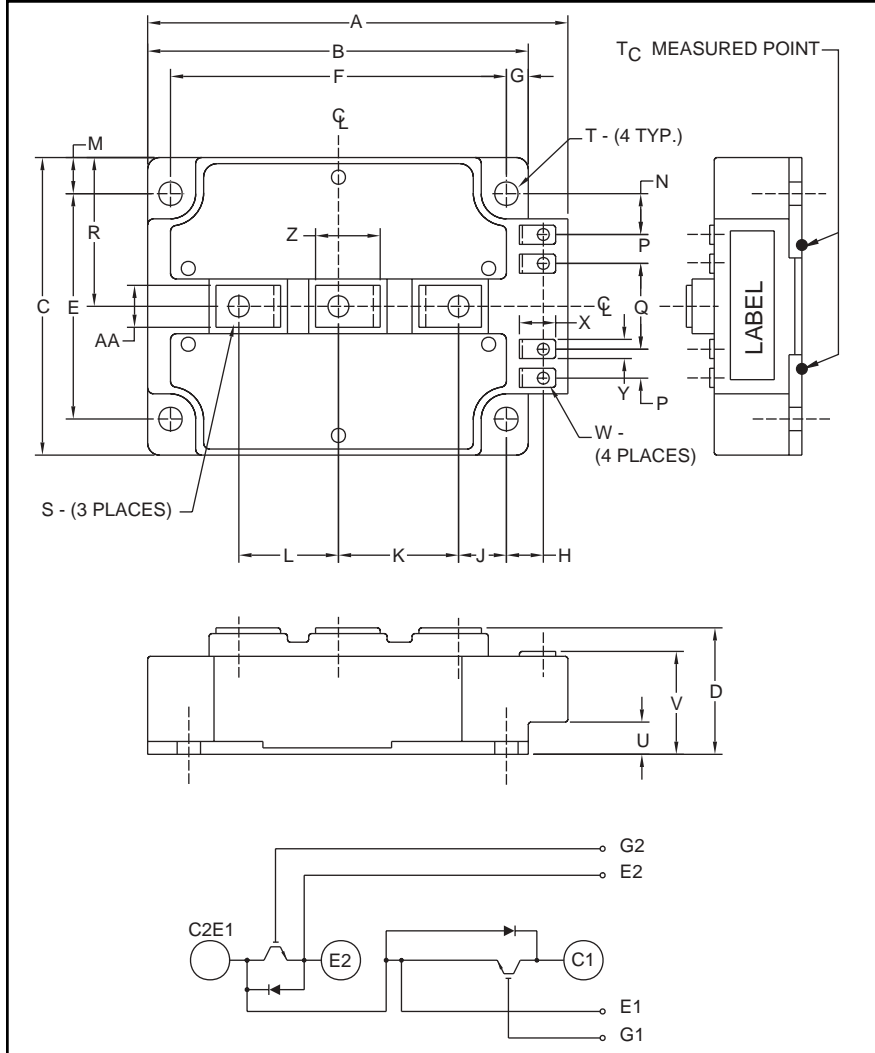

Outline Drawing and Circuit Diagram

Dimensions	Inches	Millimeters
A	5.51	140.0
B	5.12	130.0
C	5.12	130.0
D	1.38	35.0
E	4.33	110.0
F	4.33	110.0
G	0.39	10.0
H	0.45	11.5
J	0.54	13.8
K	1.72	43.8
L	1.42	36.0
M	0.39	10.0
N	0.80	20.4

Dimensions	Inches	Millimeters
P	0.57	14.5
Q	1.57	40.0
R	2.56	65.0
S	M8	M8
T	0.26 Dia.	6.5 Dia.
S	0.32	8.0
V	0.97	24.5
W	M4	M4
X	0.59	15.0
Y	0.35	9.0
Z	1.02	26.0
AA	0.79	20.0

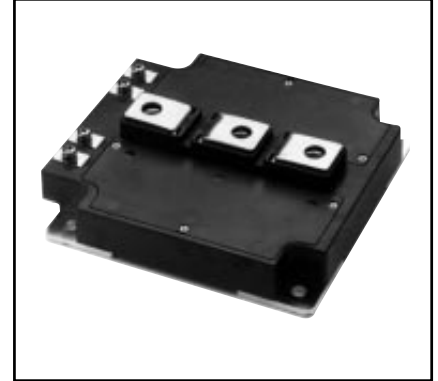

#### Description:

Powerex IGBTMOD™ Modules are designed for use in switching applications. Each module consists of two IGBT Transistors in a half-bridge configuration with each transistor having a reverse-connected super-fast recovery free-wheel diode. All components and interconnects are isolated from the heat sinking baseplate, offering simplified system assembly and thermal management.

#### Features:

- Low Drive Power
- Low  $V_{CE(sat)}$
- Discrete Super-Fast Recovery Free-Wheel Diode
- Isolated Baseplate for Easy Heat Sinking

#### Applications:

- AC Motor Control
- Motion/Servo Control
- UPS
- Welding Power Supplies
- Laser Power Supplies

#### Ordering Information:

Example: Select the complete module number you desire from the table - i.e. CM300DU-34KA is a 1700V ( $V_{CES}$ ), 300 Ampere Dual IGBTMOD™ Power Module.

Type	Current Rating Amperes	$V_{CES}$ Volts (x 50)
CM	300	34



Powerex, Inc., 200 E. Hillis Street, Youngwood, Pennsylvania 15697-1800 (724) 925-7272

**CM300DU-34KA**  
**Dual IGBTMOD™ KA-Series Module**  
 300 Amperes/1700 Volts

**Absolute Maximum Ratings,  $T_j = 25\text{ }^\circ\text{C}$  unless otherwise specified**

Ratings	Symbol	CM300DU-34KA	Units
Junction Temperature	$T_j$	-40 to 150	$^\circ\text{C}$
Storage Temperature	$T_{stg}$	-40 to 125	$^\circ\text{C}$
Collector-Emitter Voltage (G-E SHORT)	$V_{CES}$	1700	Volts
Gate-Emitter Voltage (C-E SHORT)	$V_{GES}$	$\pm 20$	Volts
Collector Current ( $T_c = 25^\circ\text{C}$ )	$I_C$	300	Amperes
Peak Collector Current	$I_{CM}$	600*	Amperes
Emitter Current** ( $T_c = 25^\circ\text{C}$ )	$I_E$	300	Amperes
Peak Emitter Current**	$I_{EM}$	600*	Amperes
Maximum Collector Dissipation ( $T_c = 25^\circ\text{C}$ , $T_j \leq 150^\circ\text{C}$ )	$P_C$	1500	Watts
Mounting Torque, M8 Main Terminal	–	95	in-lb
Mounting Torque, M6 Mounting	–	40	in-lb
G(E) Terminal, M4	–	15	in-lb
Weight	–	1200	Grams
Isolation Voltage (Main Terminal to Baseplate, AC 1 min.)	$V_{iso}$	3500	Volts

\* Pulse width and repetition rate should be such that the device junction temperature ( $T_j$ ) does not exceed  $T_{j(max)}$  rating.

\*\*Represents characteristics of the anti-parallel, emitter-to-collector free-wheel diode (FWDi).

**Static Electrical Characteristics,  $T_j = 25\text{ }^\circ\text{C}$  unless otherwise specified**

Characteristics	Symbol	Test Conditions	Min.	Typ.	Max.	Units
Collector-Cutoff Current	$I_{CES}$	$V_{CE} = V_{CES}$ , $V_{GE} = 0V$	–	–	1	mA
Gate Leakage Current	$I_{GES}$	$V_{GE} = V_{GES}$ , $V_{CE} = 0V$	–	–	0.5	$\mu\text{A}$
Gate-Emitter Threshold Voltage	$V_{GE(th)}$	$I_C = 30\text{mA}$ , $V_{CE} = 10V$	4.0	5.5	7.0	Volts
Collector-Emitter Saturation Voltage	$V_{CE(sat)}$	$I_C = 300A$ , $V_{GE} = 15V$ , $T_j = 25^\circ\text{C}$	–	3.2	4.0	Volts
		$I_C = 300A$ , $V_{GE} = 15V$ , $T_j = 125^\circ\text{C}$	–	3.8	–	Volts
Total Gate Charge	$Q_G$	$V_{CC} = 1000V$ , $I_C = 300A$ , $V_{GE} = 15V$	–	1350	–	nC
Emitter-Collector Voltage**	$V_{EC}$	$I_E = 300A$ , $V_{GE} = 0V$ , $T_j = 25^\circ\text{C}$	–	–	4.6	Volts
		$I_E = 300A$ , $V_{GE} = 0V$ , $T_j = 125^\circ\text{C}$	–	2.2	–	Volts

\*\*Represents characteristics of the anti-parallel, emitter-to-collector free-wheel diode (FWDi).

**Dynamic Electrical Characteristics,  $T_j = 25\text{ }^\circ\text{C}$  unless otherwise specified**

Characteristics	Symbol	Test Conditions	Min.	Typ.	Max.	Units
Input Capacitance	$C_{ies}$		–	–	42.0	nf
Output Capacitance	$C_{oes}$	$V_{CE} = 10V$ , $V_{GE} = 0V$	–	–	7.2	nf
Reverse Transfer Capacitance	$C_{res}$		–	–	2.3	nf
Resistive	Turn-on Delay Time	$V_{CC} = 1000V$ , $I_C = 300A$ ,	–	–	800	ns
Load	Rise Time					
Switch	Turn-off Delay Time	$R_G = 3.1\Omega$ , Resistive	–	–	1000	ns
Times	Fall Time					
Diode Reverse Recovery Time**	$t_{rr}$	Switching Operation	–	–	600	ns
Diode Reverse Recovery Charge**	$Q_{rr}$	$I_E = 300A$	–	11.2	–	$\mu\text{C}$

\*\*Represents characteristics of the anti-parallel, emitter-to-collector free-wheel diode (FWDi).



Powerex, Inc., 200 E. Hillis Street, Youngwood, Pennsylvania 15697-1800 (724) 925-7272

**CM300DU-34KA**  
**Dual IGBTMOD™ KA-Series Module**  
 300 Amperes/1700 Volts

**Thermal and Mechanical Characteristics,  $T_j = 25\text{ }^\circ\text{C}$  unless otherwise specified**

Characteristics	Symbol	Test Conditions	Min.	Typ.	Max.	Units
Thermal Resistance, Junction to Case	$R_{th(j-c)Q}$	Per IGBT 1/2 Module	–	–	0.083	$^\circ\text{C/W}$
Thermal Resistance, Junction to Case	$R_{th(j-c)D}$	Per FWDi 1/2 Module	–	–	0.13	$^\circ\text{C/W}$
Contact Thermal Resistance	$R_{th(c-f)}$	Per Module, Thermal Grease Applied	–	0.010	–	$^\circ\text{C/W}$
Thermal Resistance	$R_{th(j-c)Q}$	$T_c$ Measured Point (Under Chips - IGBT Part)	–	–	0.035*	$^\circ\text{C/W}$

\* If you use this value,  $R_{th(f-a)}$  should be measured just under the chips.

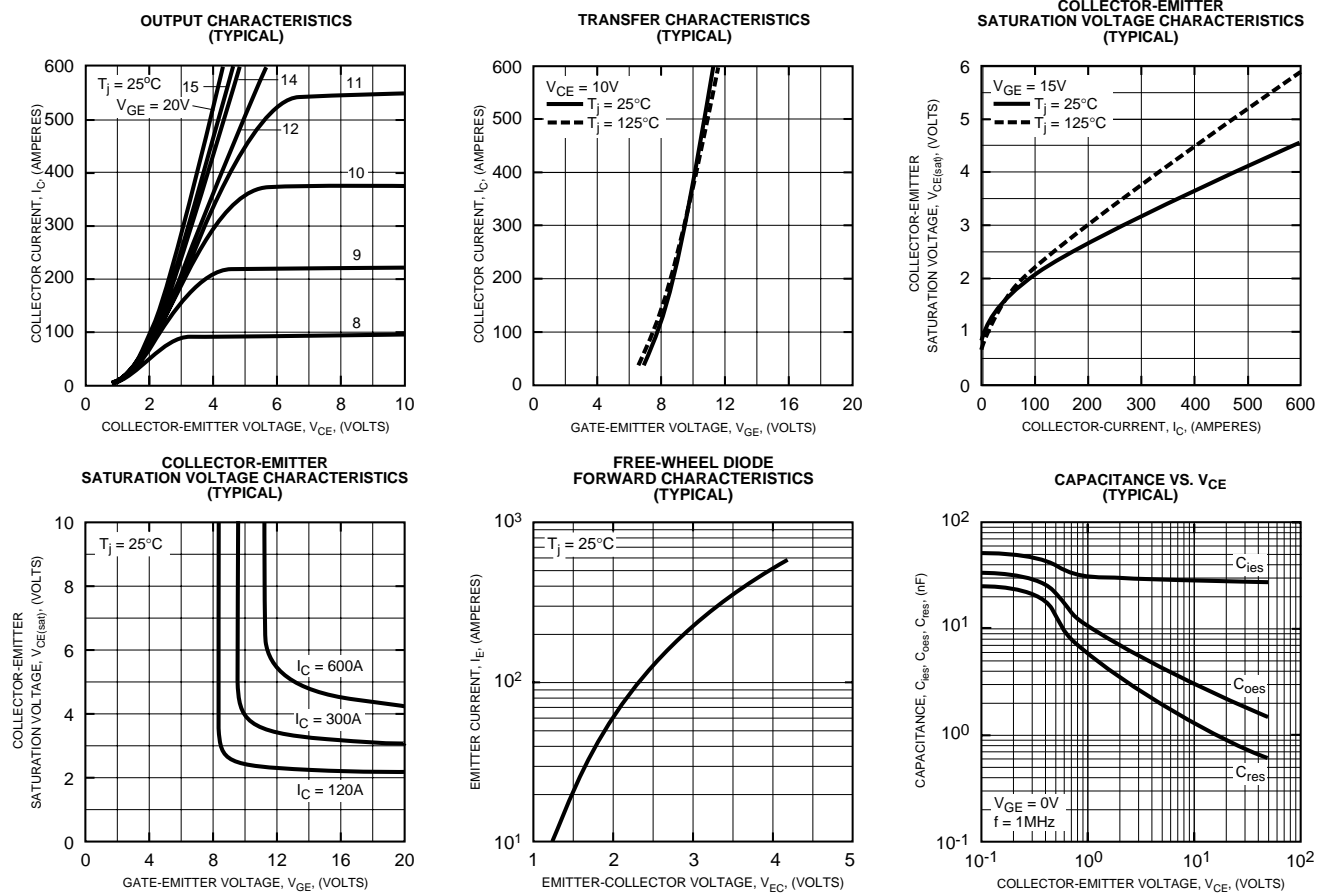

**CM300DU-34KA**  
**Dual IGBTMOD™ KA-Series Module**  
 300 Amperes/1700 Volts

**HALF-BRIDGE SWITCHING CHARACTERISTICS (TYPICAL)**

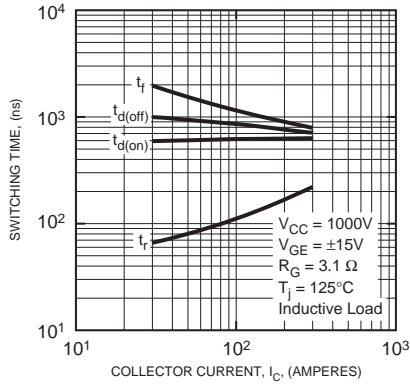

**REVERSE RECOVERY CHARACTERISTICS (TYPICAL)**

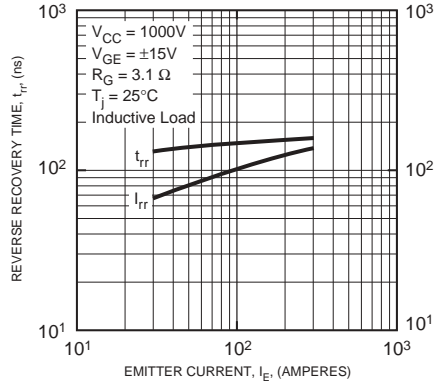

**GATE CHARGE, V<sub>GE</sub>**

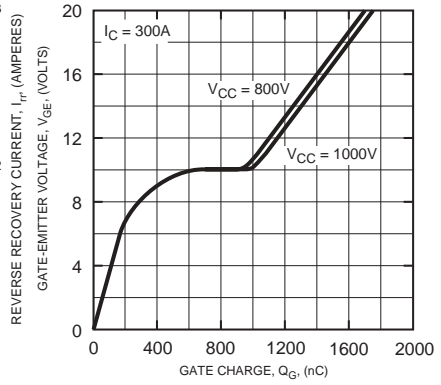

**TRANSIENT THERMAL IMPEDANCE CHARACTERISTICS (IGBT)**

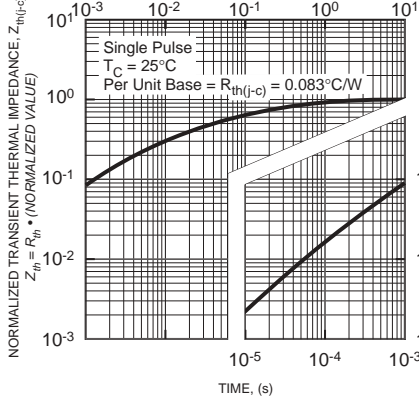

**TRANSIENT THERMAL IMPEDANCE CHARACTERISTICS (FWDi)**

