

MITSUBISHI HVIGBT MODULES
CM400HG-66H

3rd-Version HVIGBT (High Voltage Insulated Gate Bipolar Transistor) Modules

HIGH POWER SWITCHING USE
 INSULATED TYPE

CM400HG-66H



- IC 400A
- VCES 3300V
- High Insulated Type
- 1-element in a Pack
- AISiC Baseplate

APPLICATION

Traction drives, High Reliability Converters / Inverters, DC choppers

OUTLINE DRAWING & CIRCUIT DIAGRAM

Dimensions in mm

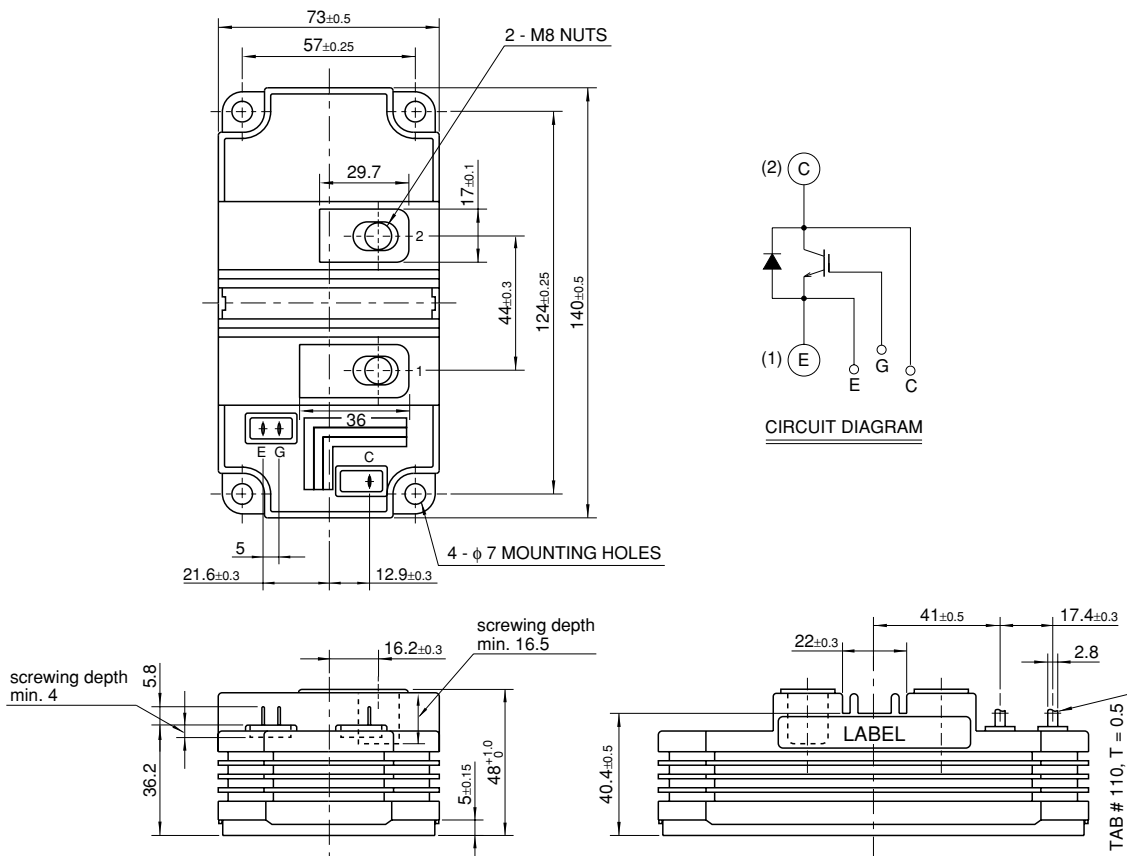

HVIGBT (High Voltage Insulated Gate Bipolar Transistor) Modules

Jul. 2005

CM400HG-66H

**HIGH POWER SWITCHING USE
INSULATED TYPE**

3rd-Version HVIGBT (High Voltage Insulated Gate Bipolar Transistor) Modules

MAXIMUM RATINGS

Symbol	Item	Conditions	Ratings	Unit
V _{CES}	Collector-emitter voltage	V _{GE} = 0V, T _j = 25°C	3300	V
V _{GES}	Gate-emitter voltage	V _{CE} = 0V, T _j = 25°C	±20	V
I _C	Collector current	T _C = 90°C	400	A
I _{CM}		Pulse (Note 1)	800	A
I _E (Note 2)	Emitter current		400	A
I _{EM} (Note 2)		Pulse (Note 1)	800	A
P _C (Note 3)	Maximum power dissipation	T _C = 25°C, IGBT part	4100	W
T _j	Junction temperature		-40 ~ +150	°C
T _{op}	Operating temperature		-40 ~ +125	°C
T _{stg}	Storage temperature		-40 ~ +125	°C
V _{iso}	Isolation voltage	RMS, sinusoidal, f = 60Hz, t = 1min.	10200	V
Q _{pd}	Partial discharge	V ₁ = 6900V _{rms} , V ₂ = 5100V _{rms} f = 60Hz (acc. to IEC 1287)	10	pC
t _{psc}	Maximum short circuit pulse width	V _{CC} = 2200V, V _{CES} ≤ 3300V, V _{GE} = 15V T _j = 125°C	10	μs

ELECTRICAL CHARACTERISTICS

Symbol	Item	Conditions	Limits			Unit
			Min	Typ	Max	
I _{CES}	Collector cut-off current	V _{CE} = V _{CES} , V _{GE} = 0V, T _j = 25°C	—	—	5	mA
V _{GE(th)}	Gate-emitter threshold voltage	I _C = 40mA, V _{CE} = 10V, T _j = 25°C	5.0	6.0	7.0	V
I _{GES}	Gate leakage current	V _{GE} = V _{GES} , V _{CE} = 0V, T _j = 25°C	—	—	0.5	μA
V _{CE(sat)}	Collector-emitter saturation voltage	I _C = 400A, V _{GE} = 15V, T _j = 25°C (Note 4)	—	3.30	4.20	V
		I _C = 400A, V _{GE} = 15V, T _j = 125°C (Note 4)	—	3.60	—	
C _{ies}	Input capacitance	V _{CE} = 10V, f = 100kHz V _{GE} = 0V, T _j = 25°C	—	60	—	nF
C _{oes}	Output capacitance		—	6.0	—	nF
C _{res}	Reverse transfer capacitance		—	5.4	—	nF
Q _g	Total gate charge	V _{CC} = 1650V, I _C = 400A, V _{GE} = 15V, T _j = 25°C	—	2.8	—	μC
V _{EC} (Note 2)	Emitter-collector voltage	I _E = 400A, V _{GE} = 0V, T _j = 25°C (Note 4)	—	2.80	3.60	V
		I _E = 400A, V _{GE} = 0V, T _j = 125°C (Note 4)	—	2.70	—	
t _{d(on)}	Turn-on delay time	V _{CC} = 1650V, I _C = 400A, V _{GE} = ±15V	—	—	1.60	μs
t _r	Turn-on rise time	R _{G(on)} = 5Ω, T _j = 125°C, L _s = 100nH	—	—	1.00	μs
E _{on}	Turn-on switching energy	Inductive load	—	0.64	—	J/pulse
t _{d(off)}	Turn-off delay time	V _{CC} = 1650V, I _C = 400A, V _{GE} = ±15V	—	—	2.50	μs
t _f	Turn-off fall time	R _{G(off)} = 5Ω, T _j = 125°C, L _s = 100nH	—	—	1.00	μs
E _{off}	Turn-off switching energy	Inductive load	—	0.52	—	J/pulse
t _{rr} (Note 2)	Reverse recovery time	V _{CC} = 1650V, I _C = 400A, V _{GE} = ±15V	—	—	1.40	μs
Q _{rr} (Note 2)	Reverse recovery charge	R _{G(on)} = 5Ω, T _j = 125°C, L _s = 100nH	—	270	—	μC
E _{rec} (Note 2)	Reverse recovery energy	Inductive load	—	0.30	—	J/pulse

- Note 1. Pulse width and repetition rate should be such that junction temperature (T_j) does not exceed T_{opmax} rating (125°C).
 2. The symbols represent characteristics of the anti-parallel, emitter to collector free-wheel diode (FWDi).
 3. Junction temperature (T_j) should not exceed T_{jmax} rating (150°C).
 4. Pulse width and repetition rate should be such as to cause negligible temperature rise.

CM400HG-66H

**HIGH POWER SWITCHING USE
INSULATED TYPE**

3rd-Version HVIGBT (High Voltage Insulated Gate Bipolar Transistor) Modules

THERMAL CHARACTERISTICS

Symbol	Item	Conditions	Limits			Unit
			Min	Typ	Max	
R _{th(j-c)Q}	Thermal resistance	Junction to Case, IGBT part	—	—	30.0	K/kW
R _{th(j-c)R}		Junction to Case, FWDi part	—	—	60.0	K/kW
R _{th(c-f)}	Contact thermal resistance	Case to Fin, $\lambda_{grease} = 1W/m \cdot K$	—	18.0	—	K/kW

MECHANICAL CHARACTERISTICS

Symbol	Item	Conditions	Limits			Unit
			Min	Typ	Max	
M	Mounting torque	M8 : Main terminals screw	7.0	—	15.0	N·m
		M6 : Mounting screw	3.0	—	6.0	
		M4 : Auxiliary terminals screw	1.0	—	3.0	
—	Mass		—	0.52	—	kg
CTI	Comparative tracking index		600	—	—	—
da	Clearance distance in air		26.0	—	—	mm
ds	Creepage distance along surface		56.0	—	—	mm

CM400HG-66H

HIGH POWER SWITCHING USE
INSULATED TYPE

3rd-Version HVIGBT (High Voltage Insulated Gate Bipolar Transistor) Modules

PERFORMANCE CURVES

OUTPUT CHARACTERISTICS
(TYPICAL)

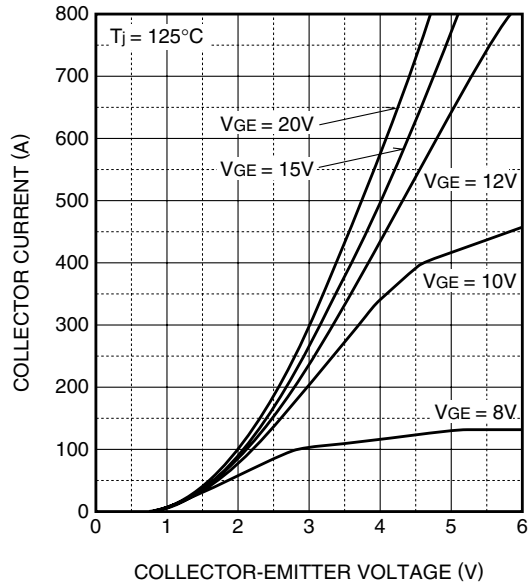

TRANSFER CHARACTERISTICS
(TYPICAL)

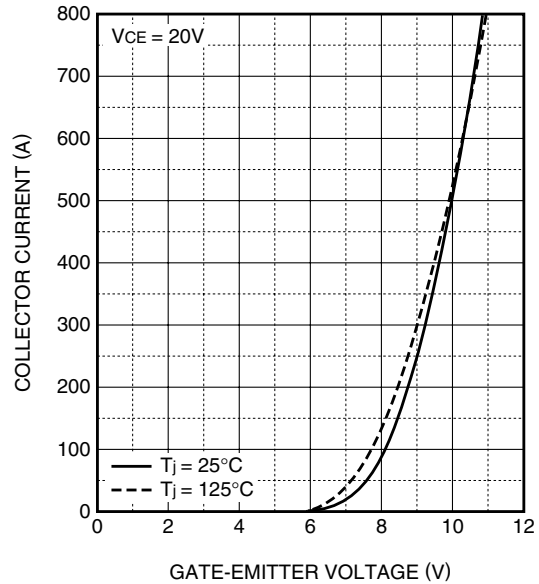

COLLECTOR-EMITTER SATURATION
VOLTAGE CHARACTERISTICS
(TYPICAL)

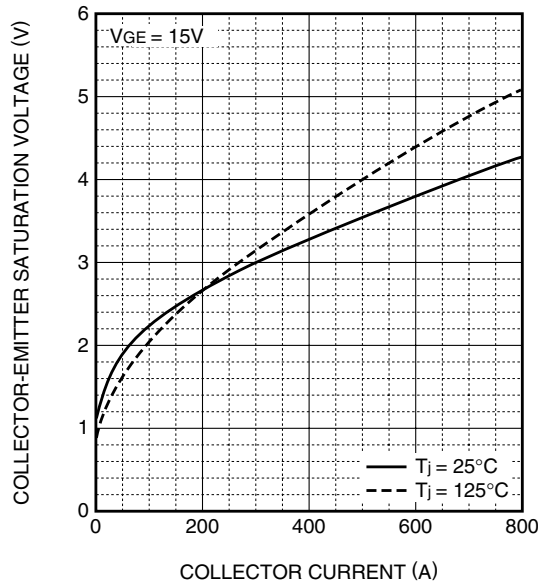

FREE-WHEEL DIODE
FORWARD CHARACTERISTICS
(TYPICAL)

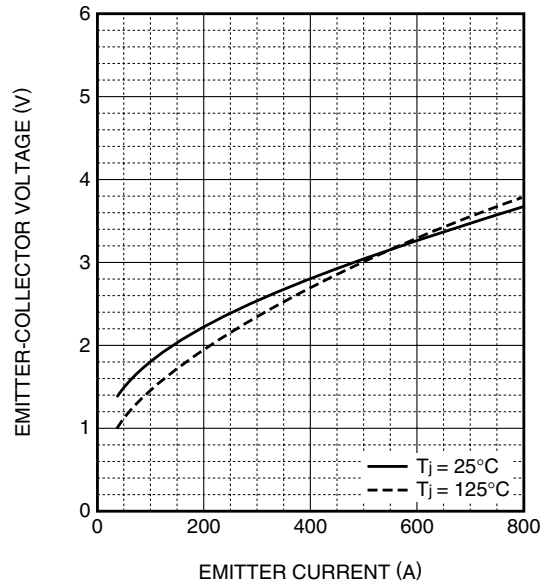

CM400HG-66H

HIGH POWER SWITCHING USE
INSULATED TYPE

3rd-Version HVIGBT (High Voltage Insulated Gate Bipolar Transistor) Modules

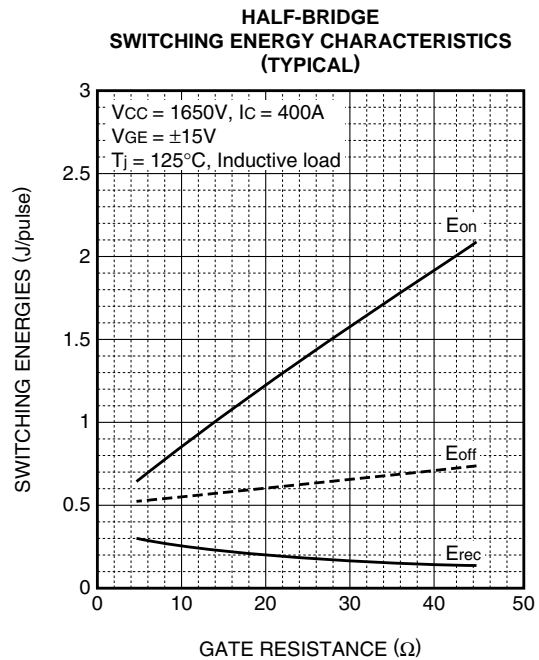
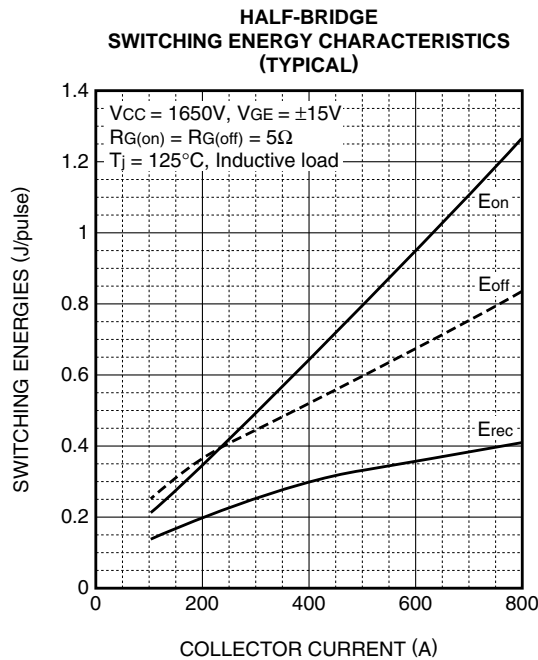
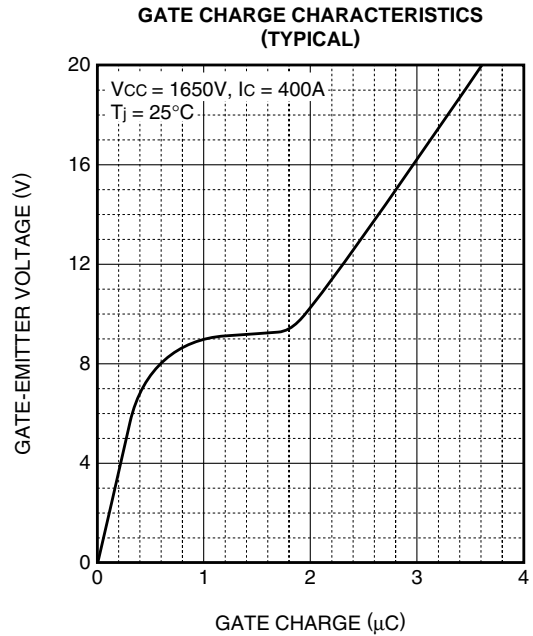
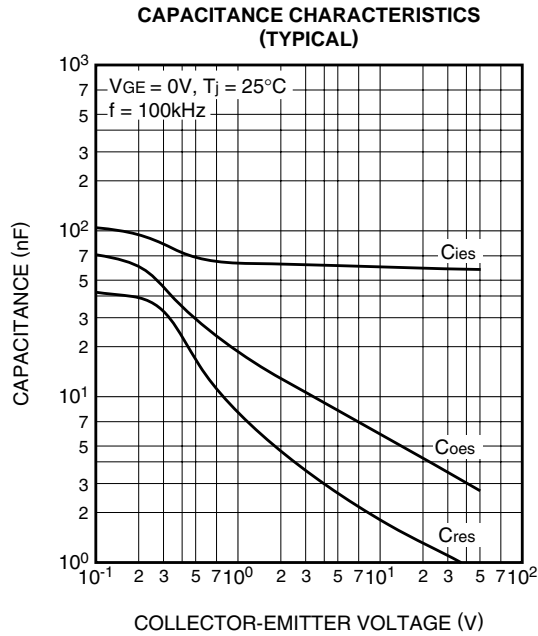

CM400HG-66H

**HIGH POWER SWITCHING USE
INSULATED TYPE**

3rd-Version HVIGBT (High Voltage Insulated Gate Bipolar Transistor) Modules

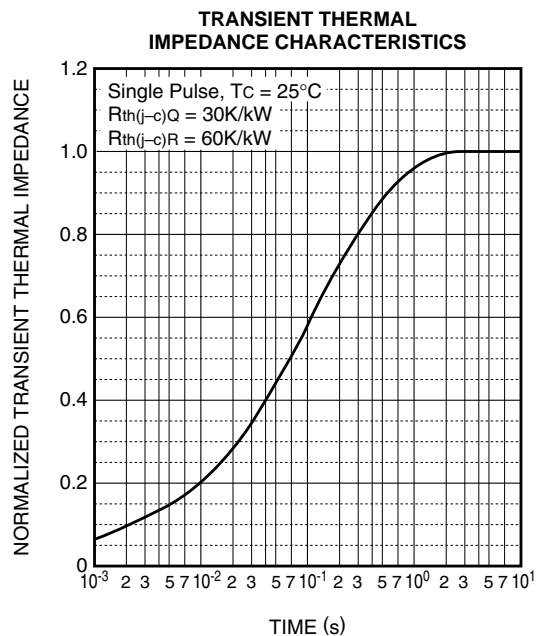
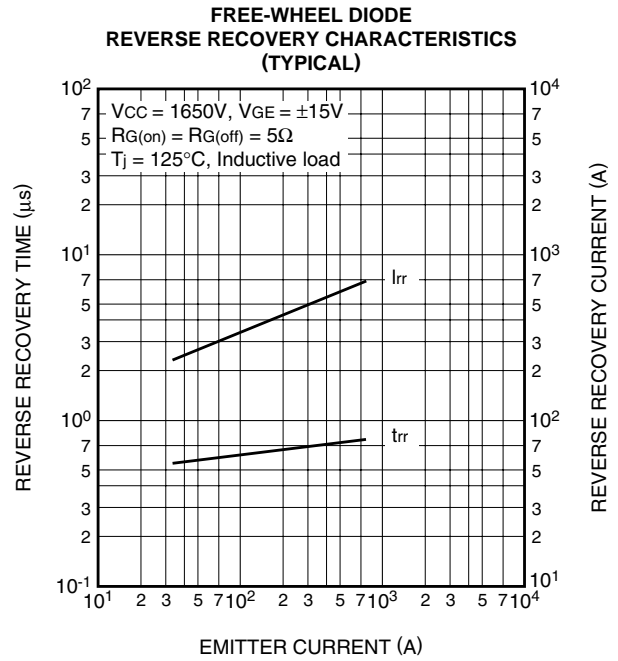
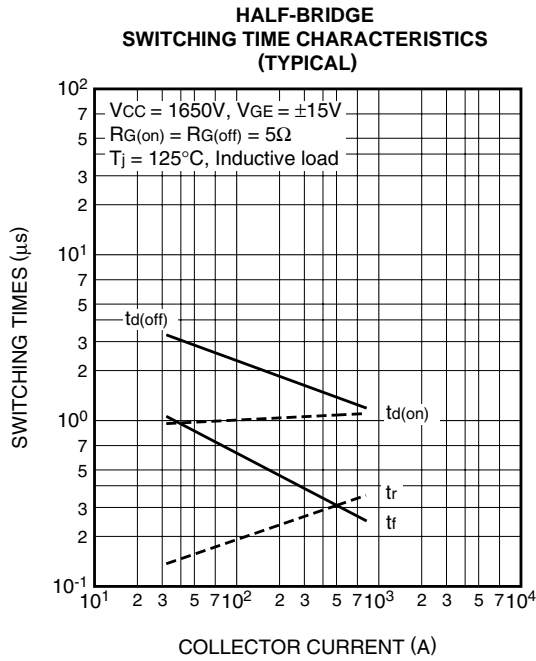

CM400HG-66H

**HIGH POWER SWITCHING USE
INSULATED TYPE**

3rd-Version HVIGBT (High Voltage Insulated Gate Bipolar Transistor) Modules

