

MITSUBISHI HVIGBT MODULES
CM600HG-90H

3rd-Version HVIGBT (High Voltage Insulated Gate Bipolar Transistor) Modules

HIGH POWER SWITCHING USE
 INSULATED TYPE

CM600HG-90H



- IC 600 A
- VCES 4500 V
- High Insulated Type
- 1-element in a Pack
- AISiC Baseplate

APPLICATION

Traction drives, High Reliability Converters / Inverters, DC choppers

OUTLINE DRAWING & CIRCUIT DIAGRAM

Dimensions in mm

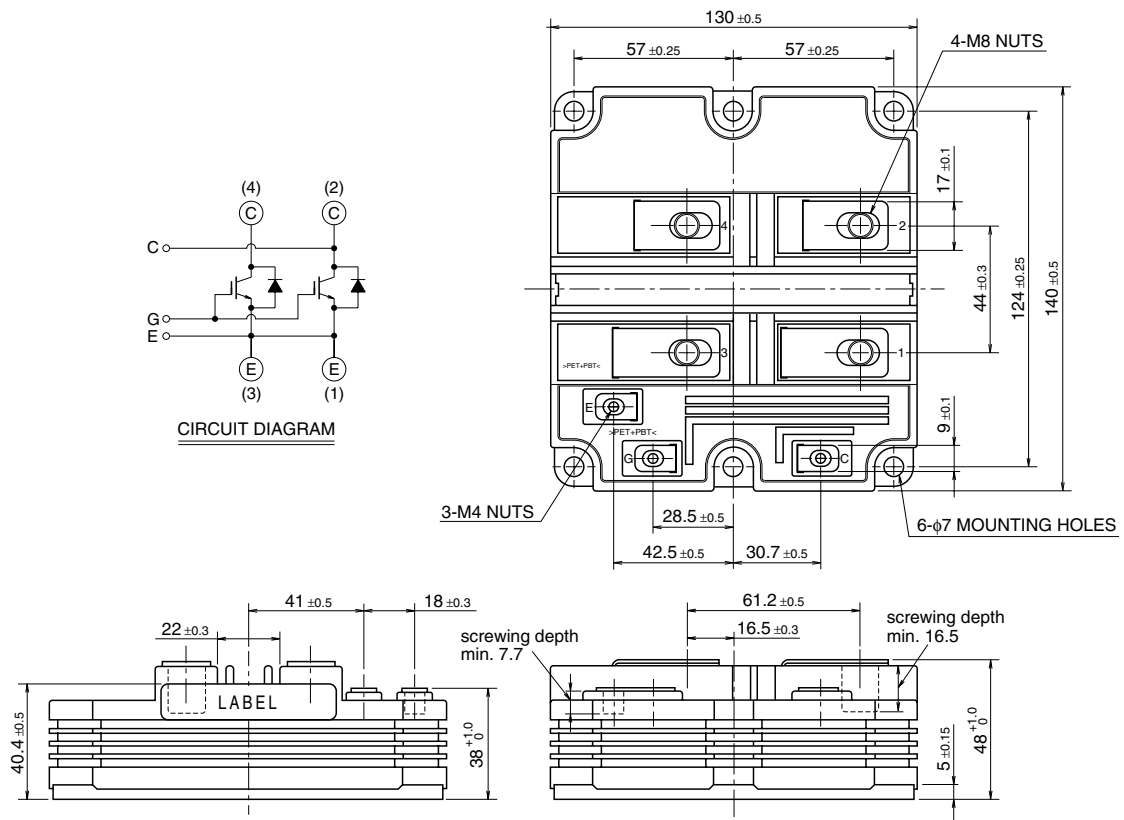

HVIGBT (High Voltage Insulated Gate Bipolar Transistor) Modules

May 2009

CM600HG-90H

**HIGH POWER SWITCHING USE
INSULATED TYPE**

3rd-Version HVIGBT (High Voltage Insulated Gate Bipolar Transistor) Modules

MAXIMUM RATINGS

Symbol	Item	Conditions	Ratings	Unit
V _{CES}	Collector-emitter voltage	V _{GE} = 0V, T _J = 25°C	4500	V
V _{GES}	Gate-emitter voltage	V _{CE} = 0V, T _J = 25°C	± 20	V
I _C	Collector current	DC, T _c = 100°C	600	A
I _{CM}		Pulse (Note 1)	1200	A
I _E	Emitter current (Note 2)	DC	600	A
I _{EM}		Pulse (Note 1)	1200	A
P _c	Maximum power dissipation (Note 3)	T _c = 25°C, IGBT part	7500	W
V _{iso}	Isolation voltage	RMS, sinusoidal, f = 60Hz, t = 1 min.	10200	V
V _e	Partial discharge extinction voltage	RMS, sinusoidal, f = 60Hz, Q _{PD} ≤ 10 pC	5100	V
T _J	Junction temperature		-40 ~ +150	°C
T _{op}	Operating temperature		-40 ~ +125	°C
T _{stg}	Storage temperature		-40 ~ +125	°C
t _{psc}	Maximum short circuit pulse width	V _{CC} = 3200V, V _{CE} ≤ V _{CES} , V _{GE} = 15V, T _J = 125°C	10	μs

ELECTRICAL CHARACTERISTICS

Symbol	Item	Conditions	Limits			Unit
			Min	Typ	Max	
I _{CES}	Collector cutoff current	V _{CE} = V _{CES} , V _{GE} = 0V				mA
		T _J = 25°C	—	—	3.5	
		T _J = 125°C	—	8	35	
V _{GE(th)}	Gate-emitter threshold voltage	V _{CE} = 10 V, I _C = 60 mA, T _J = 25°C	5.0	6.0	7.0	V
I _{GES}	Gate leakage current	V _{GE} = V _{GES} , V _{CE} = 0V, T _J = 25°C	—	—	0.5	μA
C _{ies}	Input capacitance	V _{CE} = 10 V, V _{GE} = 0 V, f = 100 kHz, T _J = 25°C	—	108	—	nF
C _{oes}	Output capacitance		—	8	—	nF
C _{res}	Reverse transfer capacitance		—	2.4	—	nF
Q _g	Total gate charge	V _{CC} = 2250 V, I _C = 600 A, V _{GE} = ±15 V, T _J = 25°C	—	10	—	μC
V _{CE(sat)}	Collector-emitter saturation voltage	I _C = 600 A (Note 4)				V
		V _{GE} = 15 V	T _J = 25°C	—	3.45	
			T _J = 125°C	—	3.70	
t _{d(on)}	Turn-on delay time	V _{CC} = 2250 V, I _C = 600 A, V _{GE} = ±15 V	—	—	2.40	μs
t _r	Turn-on rise time	R _G = 15 Ω, T _J = 125°C, L _S = 120 nH	—	—	1.20	μs
E _{on(10%)}	Turn-on switching energy (Note 5)	Inductive load	—	2.80	—	J/P
t _{d(off)}	Turn-off delay time	V _{CC} = 2250 V, I _C = 600 A, V _{GE} = ±15 V	—	—	6.00	μs
t _f	Turn-off fall time	R _G = 15 Ω, T _J = 125°C, L _S = 120 nH	—	—	1.20	μs
E _{off(10%)}	Turn-off switching energy (Note 5)	Inductive load	—	1.70	—	J/P
V _{EC}	Emitter-collector voltage (Note 2)	I _E = 600 A (Note 4)				V
		V _{GE} = 0 V	T _J = 25°C	—	4.80	
			T _J = 125°C	—	4.15	
t _{rr}	Reverse recovery time (Note 2)	V _{CC} = 2250 V, I _E = 600 A, V _{GE} = ±15 V R _G = 15 Ω, T _J = 125°C, L _S = 120 nH Inductive load	—	—	1.80	μs
Q _{rr}	Reverse recovery charge (Note 2)		—	610	—	μC
E _{rec(10%)}	Reverse recovery energy (Note 2), (Note 5)		—	0.67	—	J/P

CM600HG-90H

**HIGH POWER SWITCHING USE
INSULATED TYPE**

3rd-Version HVIGBT (High Voltage Insulated Gate Bipolar Transistor) Modules

THERMAL CHARACTERISTICS

Symbol	Item	Conditions	Limits			Unit
			Min	Typ	Max	
$R_{th(j-c)Q}$	Thermal resistance	Junction to Case, IGBT part	—	—	16.5	K/kW
$R_{th(j-c)R}$	Thermal resistance	Junction to Case, FWDi part	—	—	33.0	K/kW
$R_{th(c-f)}$	Contact thermal resistance	Case to Fin, $\lambda_{grease} = 1W/m-K$, $D(c-f) = 100 \mu m$	—	9.0	—	K/kW

MECHANICAL CHARACTERISTICS

Symbol	Item	Conditions	Limits			Unit
			Min	Typ	Max	
M_t	Mounting torque	M8: Main terminals screw	7.0	—	15.0	N·m
M_s		M6: Mounting screw	3.0	—	6.0	N·m
M_t		M4: Auxiliary terminals screw	1.0	—	3.0	N·m
m	Mass		—	1.00	—	kg
CTI	Comparative tracking index		600	—	—	—
d_a	Clearance		26	—	—	mm
d_s	Creepage distance		56	—	—	mm
LP CE	Internal inductance		—	27	—	nH
R_{CC+EE}	Internal lead resistance	$T_c = 25^\circ C$	—	0.19	—	mΩ

- Note 1. Pulse width and repetition rate should be such that junction temperature (T_j) does not exceed T_{opmax} rating (125°C).
 2. The symbols represent characteristics of the anti-parallel, emitter to collector free-wheel diode (FWDi).
 3. Junction temperature (T_j) should not exceed T_{jmax} rating (150°C).
 4. Pulse width and repetition rate should be such as to cause negligible temperature rise.
 5. $E_{on(10\%)} / E_{off(10\%)} / E_{rec(10\%)}$ are the integral of $0.1V_{CE} \times 0.1I_C \times dt$.

CM600HG-90H

HIGH POWER SWITCHING USE
INSULATED TYPE

3rd-Version HVIGBT (High Voltage Insulated Gate Bipolar Transistor) Modules

PERFORMANCE CURVES

OUTPUT CHARACTERISTICS
(TYPICAL)

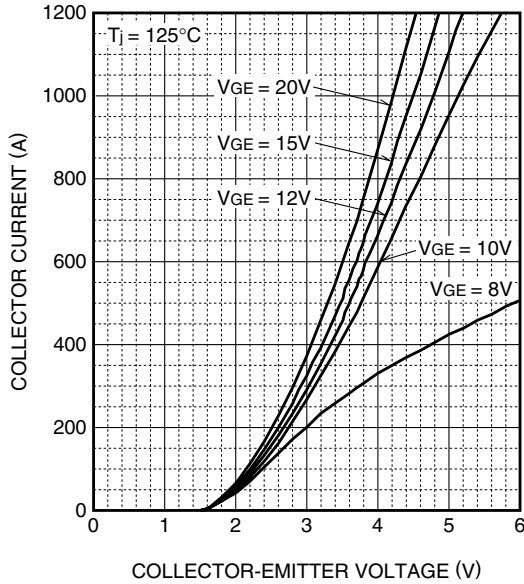

TRANSFER CHARACTERISTICS
(TYPICAL)

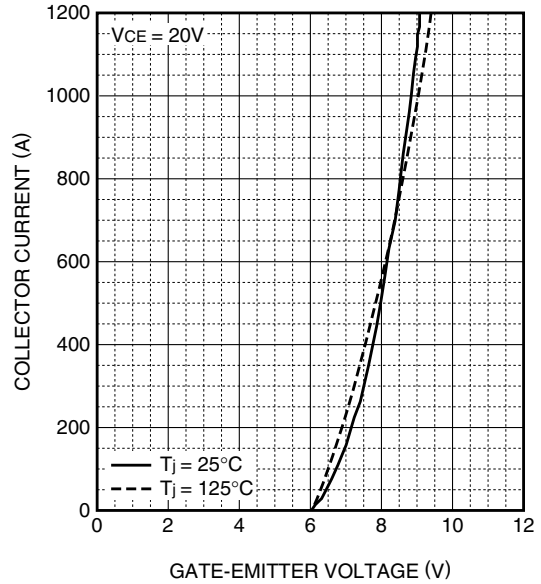

COLLECTOR-EMITTER SATURATION
VOLTAGE CHARACTERISTICS
(TYPICAL)

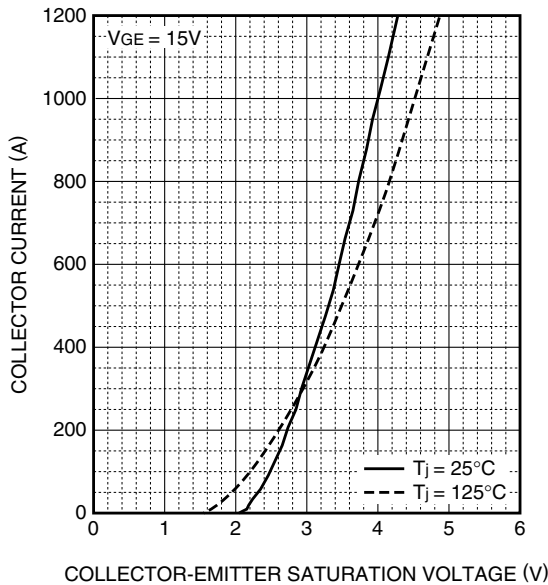

FREE-WHEEL DIODE
FORWARD CHARACTERISTICS
(TYPICAL)

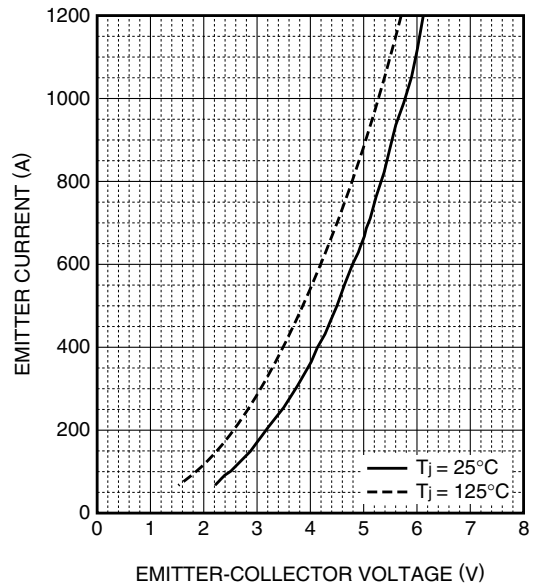

CM600HG-90H

HIGH POWER SWITCHING USE
INSULATED TYPE

3rd-Version HVIGBT (High Voltage Insulated Gate Bipolar Transistor) Modules

CAPACITANCE CHARACTERISTICS
(TYPICAL)

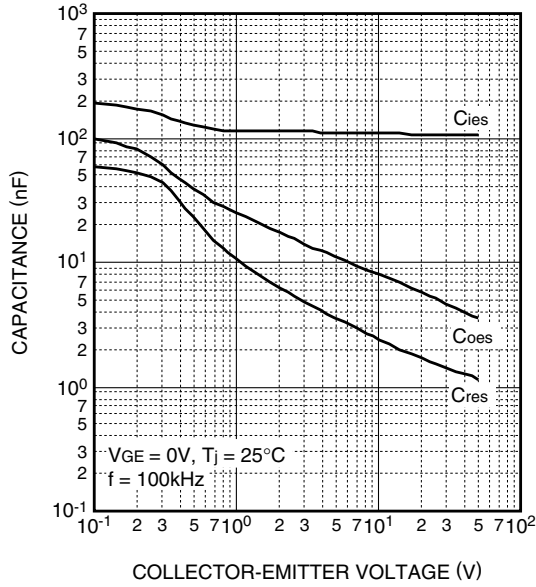

GATE CHARGE CHARACTERISTICS
(TYPICAL)

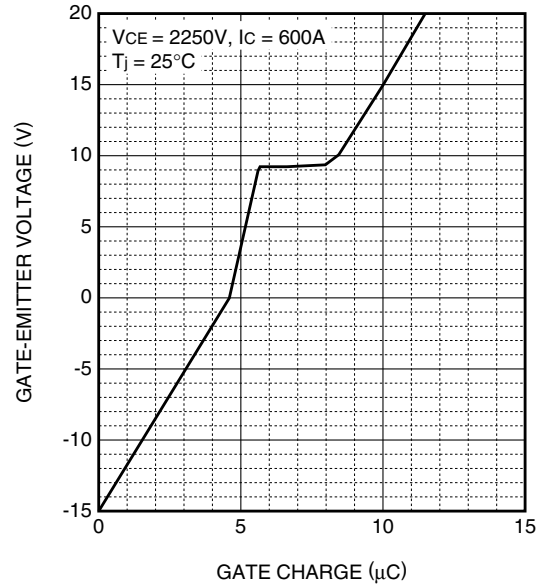

HALF-BRIDGE SWITCHING ENERGY
CHARACTERISTICS
(TYPICAL)

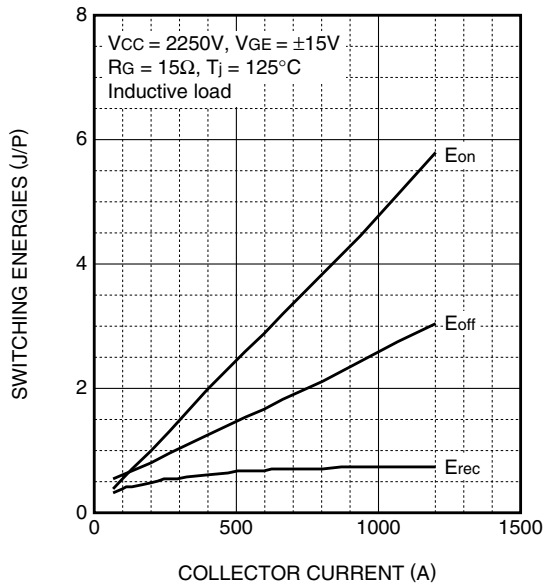

HALF-BRIDGE SWITCHING ENERGY
CHARACTERISTICS
(TYPICAL)

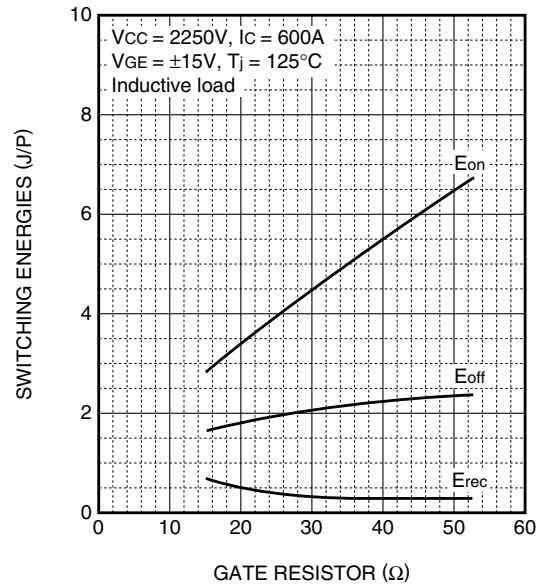

CM600HG-90H

HIGH POWER SWITCHING USE
INSULATED TYPE

3rd-Version HVIGBT (High Voltage Insulated Gate Bipolar Transistor) Modules

HALF-BRIDGE SWITCHING TIME CHARACTERISTICS (TYPICAL)

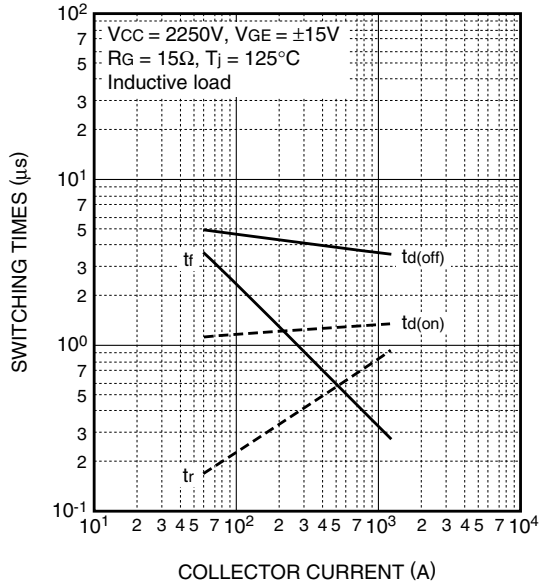

FREE-WHEEL DIODE REVERSE RECOVERY CHARACTERISTICS (TYPICAL)

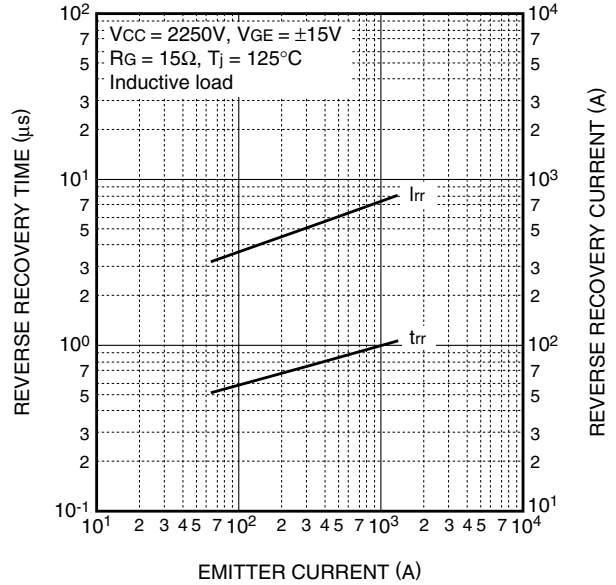

TRANSIENT THERMAL IMPEDANCE CHARACTERISTICS

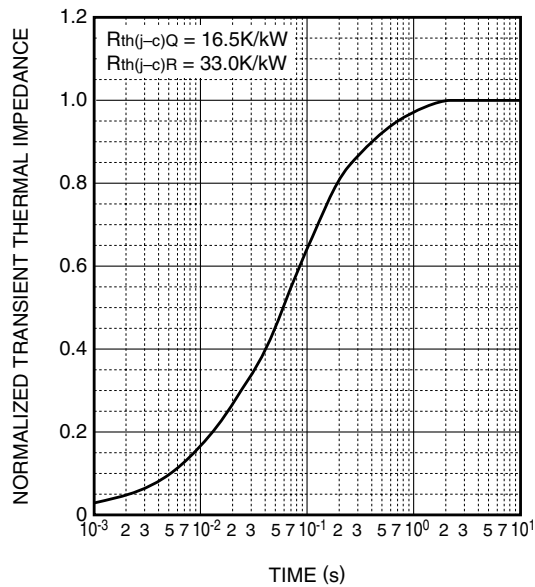

$$Z_{th(j-c)}(t) = \sum_{i=1}^n R_i \left\{ 1 - \exp\left(-\frac{t}{\tau_i}\right) \right\}$$

	1	2	3	4
R_i [K/kW]	0.0059	0.0978	0.6571	0.2392
τ_i [sec]	0.0002	0.0074	0.0732	0.4488

CM600HG-90H

**HIGH POWER SWITCHING USE
INSULATED TYPE**

3rd-Version HVIGBT (High Voltage Insulated Gate Bipolar Transistor) Modules

