

MITSUBISHI HVIGBT MODULES  
**CM800HC-66H**

3rd-Version HVIGBT (High Voltage Insulated Gate Bipolar Transistor) Modules

HIGH POWER SWITCHING USE  
 INSULATED TYPE

**CM800HC-66H**



- IC .....800A
- VCES ..... 3300V
- Insulated Type
- 1-element in a Pack
- AISiC Baseplate

**APPLICATION**

Traction drives, High Reliability Converters / Inverters, DC choppers

**OUTLINE DRAWING & CIRCUIT DIAGRAM**

Dimensions in mm

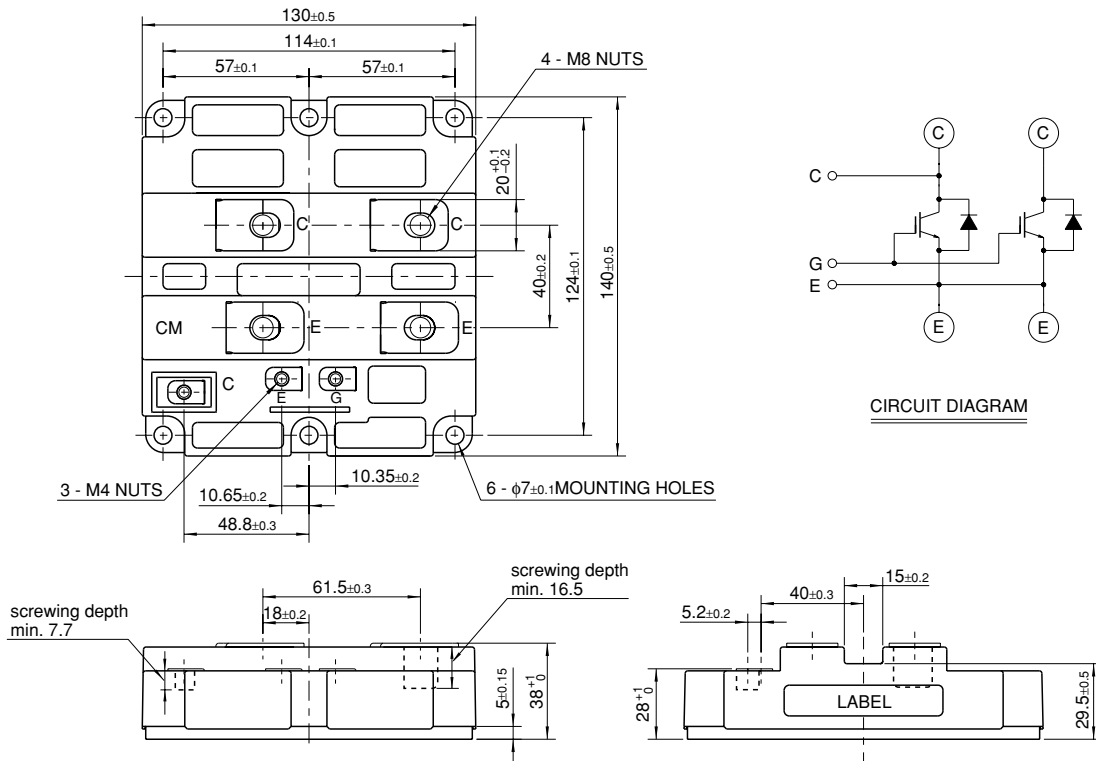

HVIGBT (High Voltage Insulated Gate Bipolar Transistor) Modules

Jul. 2005

**CM800HC-66H**

**HIGH POWER SWITCHING USE  
INSULATED TYPE**

3rd-Version HVIGBT (High Voltage Insulated Gate Bipolar Transistor) Modules

**MAXIMUM RATINGS**

Symbol	Item	Conditions	Ratings	Unit
V <sub>CE</sub> S	Collector-emitter voltage	V <sub>GE</sub> = 0V, T <sub>j</sub> = 25°C	3300	V
V <sub>GE</sub> S	Gate-emitter voltage	V <sub>CE</sub> = 0V, T <sub>j</sub> = 25°C	±20	V
I <sub>C</sub>	Collector current	T <sub>C</sub> = 100°C	800	A
I <sub>CM</sub>		Pulse (Note 1)	1600	A
I <sub>E</sub> (Note 2)	Emitter current		800	A
I <sub>EM</sub> (Note 2)		Pulse (Note 1)	1600	A
P <sub>C</sub> (Note 3)	Maximum power dissipation	T <sub>C</sub> = 25°C, IGBT part	9600	W
T <sub>j</sub>	Junction temperature		-40 ~ +150	°C
T <sub>op</sub>	Operating temperature		-40 ~ +125	°C
T <sub>stg</sub>	Storage temperature		-40 ~ +125	°C
V <sub>iso</sub>	Isolation voltage	RMS, sinusoidal, f = 60Hz, t = 1min.	6000	V
t <sub>psc</sub>	Maximum short circuit pulse width	V <sub>CC</sub> = 2200V, V <sub>CE</sub> S ≤ 3300V, V <sub>GE</sub> = 15V T <sub>j</sub> = 125°C	10	μs

**ELECTRICAL CHARACTERISTICS**

Symbol	Item	Conditions	Limits			Unit
			Min	Typ	Max	
I <sub>CE</sub> S	Collector cut-off current	V <sub>CE</sub> = V <sub>CE</sub> S, V <sub>GE</sub> = 0V, T <sub>j</sub> = 25°C	—	—	10	mA
V <sub>GE(th)</sub>	Gate-emitter threshold voltage	I <sub>C</sub> = 80mA, V <sub>CE</sub> = 10V, T <sub>j</sub> = 25°C	5.0	6.0	7.0	V
I <sub>GE</sub> S	Gate leakage current	V <sub>GE</sub> = V <sub>GE</sub> S, V <sub>CE</sub> = 0V, T <sub>j</sub> = 25°C	—	—	0.5	μA
V <sub>CE(sat)</sub>	Collector-emitter saturation voltage	I <sub>C</sub> = 800A, V <sub>GE</sub> = 15V, T <sub>j</sub> = 25°C (Note 4)	—	3.30	4.20	V
		I <sub>C</sub> = 800A, V <sub>GE</sub> = 15V, T <sub>j</sub> = 125°C (Note 4)	—	3.60	—	
C <sub>ies</sub>	Input capacitance	V <sub>CE</sub> = 10V, f = 100kHz	—	120	—	nF
C <sub>oes</sub>	Output capacitance	V <sub>GE</sub> = 0V, T <sub>j</sub> = 25°C	—	12.0	—	nF
C <sub>res</sub>	Reverse transfer capacitance		—	3.6	—	nF
Q <sub>g</sub>	Total gate charge	V <sub>CC</sub> = 1650V, I <sub>C</sub> = 800A, V <sub>GE</sub> = 15V, T <sub>j</sub> = 25°C	—	5.7	—	μC
V <sub>EC</sub> (Note 2)	Emitter-collector voltage	I <sub>E</sub> = 800A, V <sub>GE</sub> = 0V, T <sub>j</sub> = 25°C (Note 4)	—	2.80	3.60	V
		I <sub>E</sub> = 800A, V <sub>GE</sub> = 0V, T <sub>j</sub> = 125°C (Note 4)	—	2.70	—	
t <sub>d(on)</sub>	Turn-on delay time	V <sub>CC</sub> = 1650V, I <sub>C</sub> = 800A, V <sub>GE</sub> = ±15V	—	—	1.60	μs
t <sub>r</sub>	Turn-on rise time	R <sub>G(on)</sub> = 2.5Ω, T <sub>j</sub> = 125°C, L <sub>s</sub> = 100nH	—	—	1.00	μs
E <sub>on</sub>	Turn-on switching energy	Inductive load	—	1.10	—	J/pulse
t <sub>d(off)</sub>	Turn-off delay time	V <sub>CC</sub> = 1650V, I <sub>C</sub> = 800A, V <sub>GE</sub> = ±15V	—	—	2.50	μs
t <sub>f</sub>	Turn-off fall time	R <sub>G(off)</sub> = 2.5Ω, T <sub>j</sub> = 125°C, L <sub>s</sub> = 100nH	—	—	1.00	μs
E <sub>off</sub>	Turn-off switching energy	Inductive load	—	1.05	—	J/pulse
t <sub>rr</sub> (Note 2)	Reverse recovery time	V <sub>CC</sub> = 1650V, I <sub>C</sub> = 800A, V <sub>GE</sub> = ±15V	—	—	1.4	μs
Q <sub>rr</sub> (Note 2)	Reverse recovery charge	R <sub>G(on)</sub> = 2.5Ω, T <sub>j</sub> = 125°C, L <sub>s</sub> = 100nH	—	540	—	μC
E <sub>rec</sub> (Note 2)	Reverse recovery energy	Inductive load	—	0.60	—	J/pulse

- Note 1. Pulse width and repetition rate should be such that junction temperature (T<sub>j</sub>) does not exceed T<sub>opmax</sub> rating (125°C).  
 2. The symbols represent characteristics of the anti-parallel, emitter to collector free-wheel diode (FWDi).  
 3. Junction temperature (T<sub>j</sub>) should not exceed T<sub>jmax</sub> rating (150°C).  
 4. Pulse width and repetition rate should be such as to cause negligible temperature rise.



**CM800HC-66H**

**HIGH POWER SWITCHING USE  
INSULATED TYPE**

3rd-Version HVIGBT (High Voltage Insulated Gate Bipolar Transistor) Modules

**THERMAL CHARACTERISTICS**

Symbol	Item	Conditions	Limits			Unit
			Min	Typ	Max	
R <sub>th(j-c)Q</sub>	Thermal resistance	Junction to Case, IGBT part	—	—	13.0	K/kW
R <sub>th(j-c)R</sub>		Junction to Case, FWDi part	—	—	25.0	K/kW
R <sub>th(c-f)</sub>	Contact thermal resistance	Case to Fin, $\lambda_{grease} = 1W/m \cdot K$	—	8.0	—	K/kW

**MECHANICAL CHARACTERISTICS**

Symbol	Item	Conditions	Limits			Unit
			Min	Typ	Max	
M	Mounting torque	M8 : Main terminals screw	7.0	—	13.0	N·m
		M6 : Mounting screw	3.0	—	6.0	
		M4 : Auxiliary terminals screw	1.0	—	2.0	
—	Mass		—	1.0	—	kg
CTI	Comparative tracking index		600	—	—	—
d <sub>a</sub>	Clearance distance in air		19.5	—	—	mm
d <sub>s</sub>	Creepage distance along surface		32.0	—	—	mm
LC-E(int)	Internal inductance		—	18	—	nH
RC-E(int)	Internal lead resistance	T <sub>c</sub> = 25°C	—	0.20	—	mΩ

# CM800HC-66H

HIGH POWER SWITCHING USE  
INSULATED TYPE

3rd-Version HVIGBT (High Voltage Insulated Gate Bipolar Transistor) Modules

## PERFORMANCE CURVES

OUTPUT CHARACTERISTICS  
(TYPICAL)

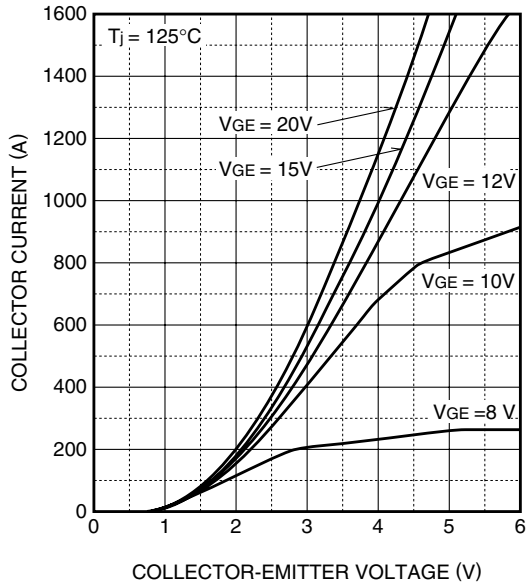

TRANSFER CHARACTERISTICS  
(TYPICAL)

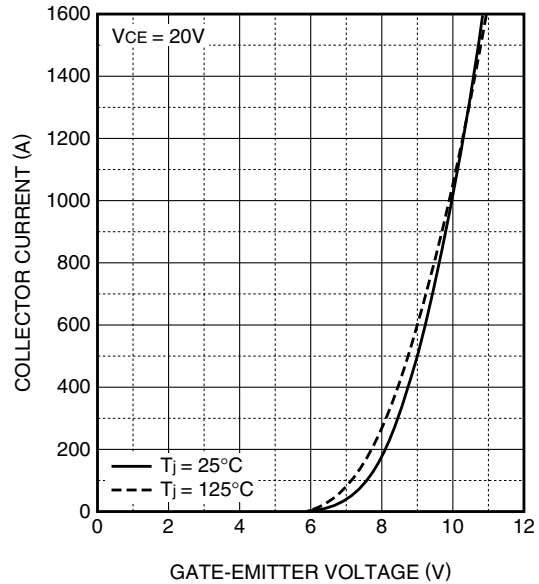

COLLECTOR-EMITTER SATURATION  
VOLTAGE CHARACTERISTICS  
(TYPICAL)

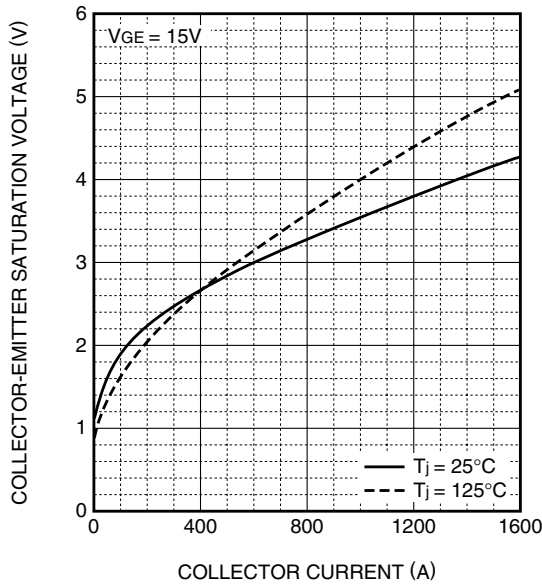

FREE-WHEEL DIODE  
FORWARD CHARACTERISTICS  
(TYPICAL)

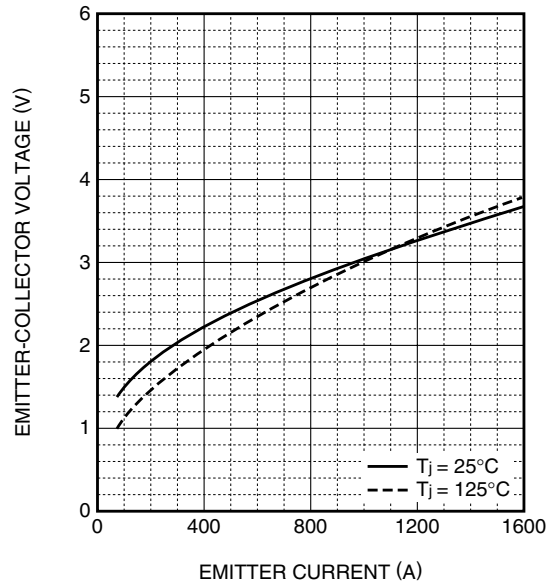

**CM800HC-66H**

**HIGH POWER SWITCHING USE  
INSULATED TYPE**

3rd-Version HVIGBT (High Voltage Insulated Gate Bipolar Transistor) Modules

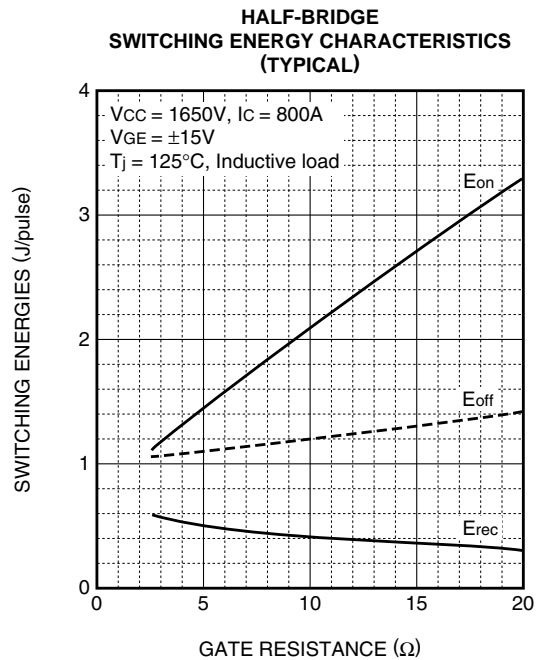
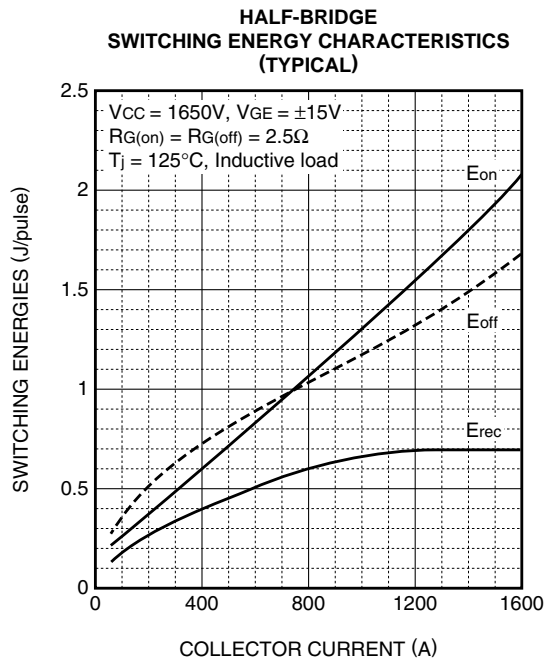
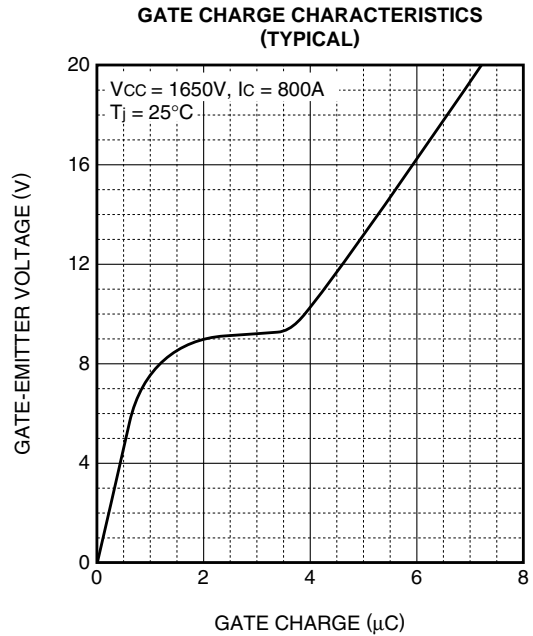
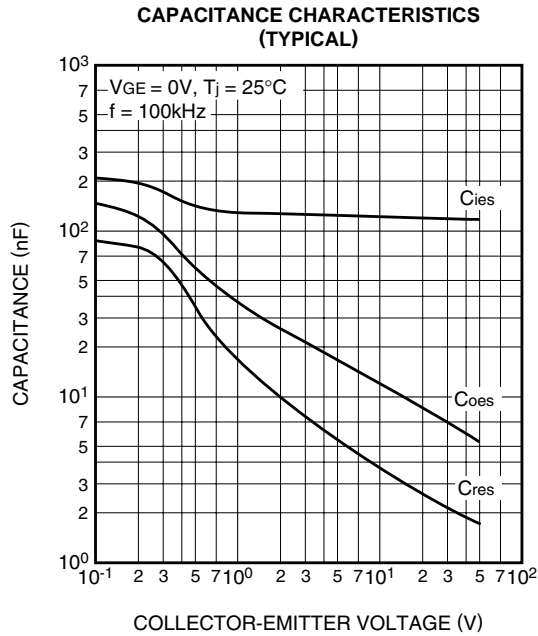

**CM800HC-66H**

**HIGH POWER SWITCHING USE  
INSULATED TYPE**

3rd-Version HVIGBT (High Voltage Insulated Gate Bipolar Transistor) Modules

**HALF-BRIDGE  
SWITCHING TIME CHARACTERISTICS  
(TYPICAL)**

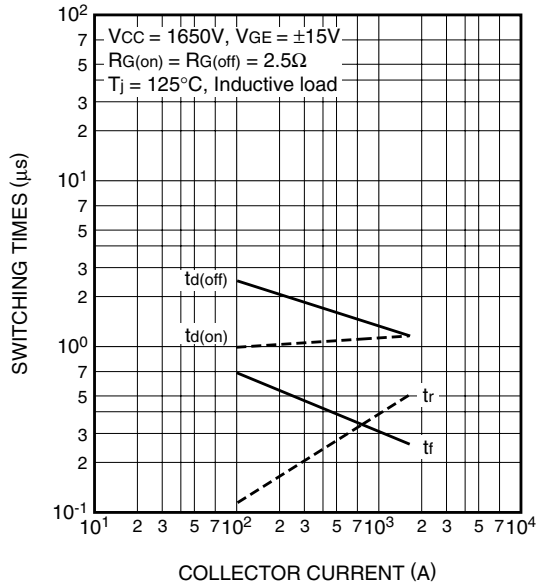

**FREE-WHEEL DIODE  
REVERSE RECOVERY CHARACTERISTICS  
(TYPICAL)**

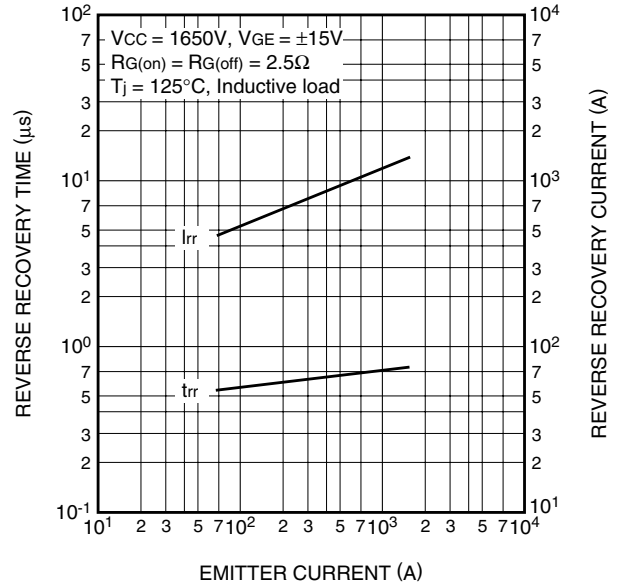

**TRANSIENT THERMAL  
IMPEDANCE CHARACTERISTICS**

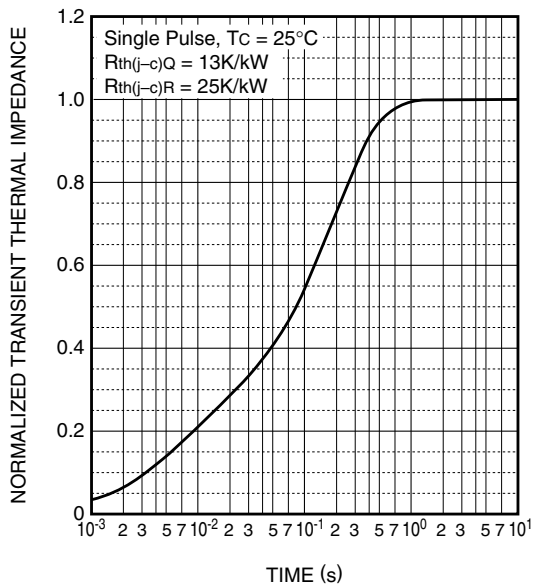

**CM800HC-66H**

**HIGH POWER SWITCHING USE  
INSULATED TYPE**

3rd-Version HVIGBT (High Voltage Insulated Gate Bipolar Transistor) Modules

